



Wholesale Building Specialties

Product Catalogue

Phone: 1-800-334-0541

Fax: 1-732-905-5305

www.wholesalebuildingspecialties.com

2025



Product Catalogue

Table of Contents

September 2025

Section 1: Masonry Accessories

- Rebar 1
- Slab Bolsters 1
- Double & Triple Chairs, 1
- Jones Bond Clamps, 1
- Rebar Caps, 1
- Rebar Wire Ties, 2
- Rebar Tie Wire & Twisters, 2
- Steel Nail Stakes, 3
- Block Mesh (Durawall), 3
- Concrete Wire Mesh, 4
- Anchor Bolts, 4-5
- Nuts/Washers for Anchor Bolts, 5
- Bearing Plates, 5
- Wall Ties, 6
- PVC Control Joint, 6
- Lime, 6
- Fiber Forms, 7
- Poly Sheeting, 8
- Angle Iron, 9
- Aluminum Flashing, 10
- Copper Flashing, 10
- Lally Columns, 11
- Lally Column Plates, Base Sets, Accessories, 12

Section 2: Foundation Doors, Air & Flood Vents, Windows, and Area Walls

- Foundation Air Vents, 13
- Vinyl Basement Windows, 14
- Foundation Access Doors, 15
- Bilco Foundation Doors, 15
- Bilco Door Extensions, 17
- Bilco Door Locks / Stair Stringers, 18
- Bilco Foundation Plates, 18
- Bilco StackWel / ScapeWel Window Wells, 19
- Galvanized Area Walls, 20

Section 3: Expansion Joints / Homasote Boards

- Fiber Expansion Joint, 21
- Homex Expansion Joint, 21
- Rubber Expansion Joint, 22
- Polypropylene Expansion Joint, 22
- Mortex Control Joint, 23
- Expanded Poly Expansion Joint W/ Peel, 24
- Expansion Joint Holders and Snap-Caps, 24
- Homasote Board Products, 25



Product Catalogue

Table of Contents

September 2025

Section 4: Fireplaces, Dampers, and Accessories

- Fireplace Boxes, 26
- Ash Dumps & Caddies, 26
- Cleanout Doors, 26
- Airkits, 26
- Keeper Hasp, 26
- Brick Vents, 26
- Rotary Control, 26
- Dampers, 27
- Damper Accessories, 27
- Chimney Flue Caps & Legs, 28
- Fire Brick, 29
- Fire Clay, 29
- Refractory Mortar (Heat Stop), 29
- Clay Flue Rings, 30
- Clay Flue Liners, 30

Section 5: Wheelbarrows, Shovels and Various Hand Tools

- Wheelbarrows, 31
- Wheelbarrow Parts, 31
- Mixing Boxes, 32
- Mixing Pans & Stands, 32
- Shovels, 33
- Rakes, 33
- Tampers, 33
- Hoes, 33
- Axes, Hammers, Post Hole Diggers, Lute, 33

Section 6: Pipe and Fittings

- Corrugated Pipe, 34
- Corrugated Pipe Fittings, 35
- Sewer & Drain Pipe (Sch 20/ PVC), 36
- Sewer & Drain Pipe (Sch 20 /PVC) Fittings, 37
- Fernco (Sewer & Drain to Cast Iron) Fittings, 38
- Sewer & Drain Pipe (Sch 20 /PVC) Cement/Primer, 38
- Solvent Weld & Gasket SDR35 Pipe, 38
- Solvent Weld & Gasket SDR35 Pipe Fittings, 38
- Schedule 40 Pipe, 39
- Schedule 40 Pipe Fittings, 39

Section 7: Drainage Products

- Sump Pits & Wells (& Lids), 40
- Bell Traps, 41
- Grates – Cast Iron Square Flat, 41
- Grates – Cast Iron Trench, 41
- Manhole Covers and Frames – Cast Iron, 41
- Tuf-Tite Linear Drainage System, 42
- E-Z Drains Linear Drainage System, 43
- Red-E-Form Linear Drainage System, 43
- Drain Rite Linear Drainage System, 44
- Pave Rite Linear Drainage System, 45
- Weep Holes & Screed, 46
- Cell Vents, 46



Product Catalogue

Table of Contents

September 2025

Section 8: Hardscapes and Geotextiles

- ADA Tactile Mats, 47
- Landscape Fabric, 49
- Geo Grid, 49
- Filter Fabric, 49
- Stabilization Fabric, 49
- Fencing (Silt, Safety, Snow), 50
- Polymeric Sand, 51
- Caution Tape, 52
- Contractor Poly Clean-up Bags, 52
- Pallet Covers, 52
- Sand Bags, 52
- Stretch Film, 52
- Reinforced Poly for Scaffolding, 52
- Ice Melt Products, 53

Section 9: Veneer Products and Accessories

- Metal Lath, 54
- #15 Felt Paper (Asphalt Saturated), 55
- Stucco Casing & Corner Beads, 55
- Stucco Expansion Control Joint, 55
- Exterior Wall Drainage - Rainscreen 55
- Foundation Soil Drainage, 57
- Stucco (Conv. & Acrylic), 58-59
- Thin Set (Conv. and Poly-Mod), 60
- Repair Mortar, 61

Section 10: Caulks & Chemicals - Damproofing, Waterproofing, Cleaners, Sealants, Coatings, Adhesives, Etc.

- Winter Admixture for Cement, 62
- Waterproofing Sealant, 63
- Construction Sealant, 63
- Construction and Adhesive Sealant, 64
- Construction Adhesive, 64
- Anchoring Adhesive, 65
- Grout, 65
- Surface Retardant, 66
- Self-Leveling Joint Sealant, 66
- Water Repellants, 67-68
- Cement Bonding Agents "Admixture", 68
- Cement Bonding Agents "Surface Applied", 69
- Waterproof Coatings, 70
- Quickset Hydraulic Cement Additive, 70
- Decorative Cement Treatments, 71
- Foundation Coating, 72-73
- Liquid Surface Curing, Hardening, Sealing, 74
- Form Release & Coating, 75
- Roof Cement & Coating, 75
- Concrete/Paver Cleaners and Restorers, 76-81

Section 1: Masonry Accessories

Rebar - Steel Reinforcing Rods, Grade 60

Order Code	Product Description	Packaged	Min Order
RB310	Rebar #3 Graded 3/8" x 10'	100/bundle	1 bundle
RB320	Rebar #3 Graded 3/8" x 20'	266/bundle	1 bundle
RB41	Rebar #4 Graded 1/2" x 12" (1 foot)	150/bundle	1 bundle
RB410	Rebar #4 Graded 1/2" x 10'	150/bundle	1 bundle
RB42	Rebar #4 Graded 1/2" x 24" (2 feet)	150/bundle	1 bundle
RB420	Rebar #4 Graded 1/2" x 20'	150/bundle	1 bundle
RB43	Rebar #4 Graded 1/2" x 36" (3 feet)	150/bundle	1 bundle
RB510	Rebar #5 Graded 5/8" x 10'	96/bundle	1 bundle
RB520	Rebar #5 Graded 5/8" x 20'	96/bundle	1 bundle
RB620	Rebar #6 Graded 3/4" x 20'	68/bundle	1 bundle



Grade 60 Rebar: Minimum yield strength of 60,000 pounds per square inch well-suited for medium- to heavy-duty concrete reinforcement applications

Slab Bolsters (Chairs) / Double or Triple Chairs / Bond Clamps / Rebar Caps

Order Code	Product Description	Packaged	Min Order
SBUP2	Slab Bolster (Chairs) Upper 2" x 5'	20/bundle	1 bundle
SBUP	Slab Bolster (Chairs) Upper 3" x 5'	20/bundle	1 bundle
SBUP4	Slab Bolster (Chairs) Upper 4" x 5'	20/bundle	1 bundle
DBL	Double Rebar Chairs	100/box	1 box
TRIP	Triple Rebar Chairs	100/box	1 box
RBC12	Rebar Jones Bond Clamp 1/2"	per clamp	1 clamp
RBC58	Rebar Jones Bond Clamp 5/8"	per clamp	1 clamp
RBCAPS	Rebar Caps (OSHA Approved)	50/box	1 box

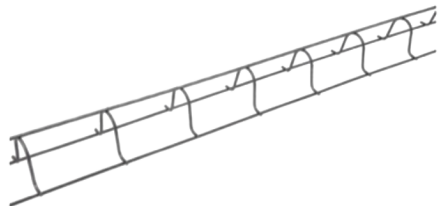

Upper Slab Bolsters are used to support top layers of steel using the bottom layer of steel as a support base.

- Particularly effective for use on slabs on grade where lower layer of steel is supported on wire chairs with plate or on concrete block.
- Wire leg spacing same as Slab bolster with addition of 7 gauge runner wire welded continuously to each leg

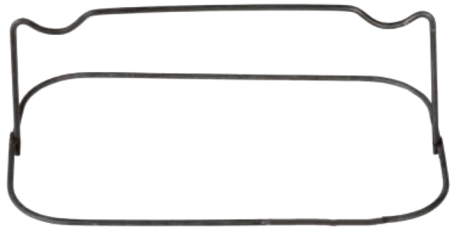

Double or Triple Rebar Chairs hold and elevate rebar & wire mesh off the ground. Accurately locate and firmly hold in place all reinforcing steel before and during the pouring of concrete.

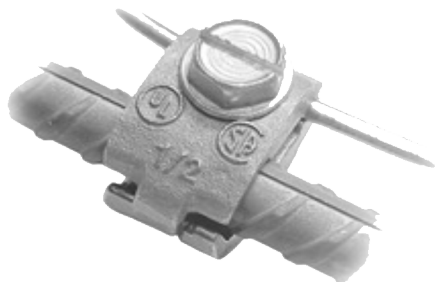

Jones Bond™ Lay-in Rebar Clamp for Continuous Loop Grounding / Bonding - Pool / Spa bonding and grounding - “Ufer” Grounding (concrete encased electrodes) - Replaces Exothermic Welding - Installs quickly, grips rebar firmly between ridges with special teeth
Bronze body, stainless steel screw for direct burial - CSA Certified for direct burial in earth and concrete on rebar

Bar Ties

Order Code	Product Description	Packaged	Min Order
BART4	Rebar Wire Ties 4" (1,000/roll)	5 rolls/bag	1 bag
BART5	Rebar Wire Ties 5" (1,000/roll)	5 rolls/bag	1 bag
BART6	Rebar Wire Ties 6" (1,000/roll)	5 rolls/bag	1 bag
BART8	Rebar Wire Ties 8" (1,000/roll)	5 rolls/bag	1 bag

“Note that 6” is the most popular size”



Rebar Tie Wire features eyehooks on the bar-tie ends to allow fast securing by hand or fastening tool. It helps rebar maintain its position during concrete placement.

Tie Wire / Twisters

Order Code	Product Description	Packaged	Min Order
TIE	Tie Wire 16Ga. B/A 3.5 LB.COIL	20/box	1 box
AT	Automatic Tie Wire Twister Tool	per tool	1 tool
MT	Manual Tie Wire Twister Tool	per tool	1 tool



Tie Wire Made of black annealed steel, the 16 gauge 3.5 roll of tie wire is strong enough to bundle rods, pipe and lumber. No tool box should be without a roll.

Steel Stakes (Concrete Pins / Round Stakes & Flat Nail Types) and Steel Pins

Order Code	Product Description	Packaged	Min Order
SS12R	3/4"x 12" Round Nail Stakes	25/box	1 box
SS18R	3/4"x 18" Round Nail Stakes	10/box	1 box
SS24R	3/4"x 24" Round Nail Stakes	10/box	1 box
SS30R	3/4"x 30" Round Nail Stakes	10/box	1 box
SS36R	3/4"x 36" Round Nail Stakes	10/box	1 box
SS42R	3/4"x 42" Round Nail Stakes	10/box	1 box
SS48R	3/4"x 48" Round Nail Stakes	10/box	1 box
SS18F	18" FLAT Steel Nail Stakes	10/box	1 box
SS24F	24" FLAT Steel Nail Stakes	10/box	1 box
SS30F	30" FLAT Steel Nail Stakes	10/box	1 box
SS36F	36" FLAT Steel Nail Stakes	10/box	1 block
SS36RFP	Round Steel Form PINS 7/8"x 36"	10/box	1 box
SS42RFP	Round Steel Form PINS 7/8"x 42"	10/box	1 box



Round and Flat Stakes are used primarily with wood forms for concrete placement jobs, but also can be used in a general purpose or landscaping function as well.

Galvanized, Truss Style Block Mesh "Durawall" – 50 pieces per bundle (10' pieces)

Order Code	Product Description	Packaged	Min Order
BM4	Block Mesh #4 Truss GALV.	500'/Bundle	1 bundle
BM6	Block Mesh #6 Truss GALV.	500'/Bundle	1 bundle
BM8	Block Mesh #8 Truss GALV.	500'/Bundle	1 bundle
BM10	Block Mesh #10 Truss GALV.	500'/Bundle	1 bundle
BM12	Block Mesh #12 Truss GALV.	500'/Bundle	1 bundle

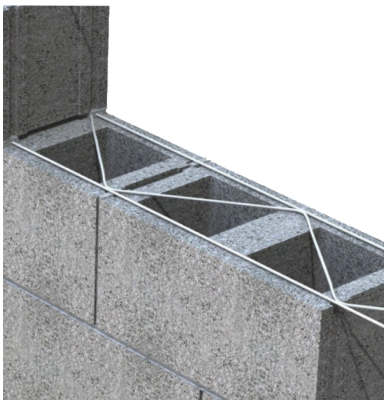

Truss style Block Mesh (i.e.: Durawall) is a continuous length of joint reinforcement that is embedded into the horizontal mortar joints of masonry walls.

* 10 bundles per skid

Concrete Wire Mesh - Rolls and Mats

Order Code	Product Description	Packaged	Min Order
661010150WM	Wire Mesh ROLLS 6x6x10/10x5'x150' (Typically sold in half skids of 9 or full skids of 18)	per roll	1 roll
661010510WM	Wire Mesh MATS 6x6x*10/10*x5'x10' - STANDARD	100/bundle	1 bundle
6666510WM	Wire Mesh MATS 6x6x*6/6*x5'x10' - HEAVY	100/bundle	1 bundle
6688510WM	Wire Mesh MATS 6x6x*8/8*x5'x 10' - MEDIUM	100/bundle	1 bundle



Wire Mesh is available in both rolls and sheets. When properly placed in concrete slabs on grade, wire mesh helps reinforce the concrete after cracking and is a critical element in its performance.

Wire Mesh Mat



Wire Mesh Roll

Anchor Bolts (Regular & Galvanized)

Order Code	Product Description	Packaged	Min Order
ABG10	GALV. Anchor Bolts 1/2"x 10"	50/box	1 box
ABG12	GALV. Anchor Bolts 1/2"x 12"	50/box	1 box
ABG1258	GALV. Anchor Bolts 5/8"x 12"	25/box	1 box
ABG14	GALV. Anchor Bolts 1/2"x 14"	50/box	1 box
ABG16	GALV. Anchor Bolts 1/2"x 16"	50/box	1 box
ABG1658	GALV. Anchor Bolts 5/8"x 16"	25/box	1 box
ABG18	GALV. Anchor Bolts 1/2"x 18"	50/box	1 box
ABG1834	GALV. Anchor Bolt 3/4"x 18"	20/box	1 box
ABG1858	GALV. Anchor Bolts 5/8"x 18"	25/box	1 box
ABG20	GALV. Anchor Bolts 1/2"x 20"	50/box	1 box
ABG6	GALV. Anchor Bolts 1/2"x 6"	50/box	1 box
ABG8	GALV. Anchor Bolts 1/2"x 8"	50/box	1 box
ABG858	GALV. Anchor Bolts 5/8"x 8"	25/box	1 box

Nuts and Washers for Anchor Bolts

Order Code	Product Description	Packaged	Min Order
NW	Nuts & Washers 1/2"	50/bag	1 bag
NWG	GALV. Nuts & Washers 1/2"	50/bag	1 bag
NWG58	GALV. Nuts & Washers 5/8"	25/bag	1 bag



Anchor bolts or foundation bolts are embedded in concrete foundations to support structural steel columns, light poles, traffic signals, highway sign structures, industrial equipment and many other applications.

Bearing Plates "Hurricane Washers"

Order Code	Product Description	Packaged	Min Order
BP34G	Bearing Plate 3"x3"x1/4" w/3/4"Hole	20/box	1 box
BP58G	Bearing Plate 3"x3"x1/4" w/5/8"Hole	25/box	1 box



Bearing plates give greater bearing surface than standard cut washers, and help distribute the load at these critical connections.

Wall Ties - 22/28 Gauge

Order Code	Product Description	Packaged	Min Order
WT22	Wall Ties 22 Gauge	500/box	1 box
WT28	Wall Ties 28 Gauge	500/box	1 box

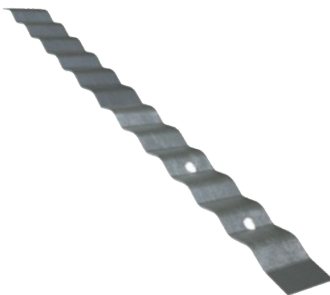

Corrugated Wall Ties are for anchoring wood studs to masonry. This product is only recommended for use in residential construction. Standard size is 7/8" wide X 7" long.

PVC Block Control Joint

Order Code	Product Description	Packaged	Min Order
BCJ-1	PVC Block Control Joint 2-5/8"	60 feet/box	1 box
BCJ-3	PVC Block Control Joint 6-7/8" (8"Block)	60 feet/box	1 box
BCJ-4	PVC Block Control Joint 11-1/8" (12"Block)	40 feet/box	1 box

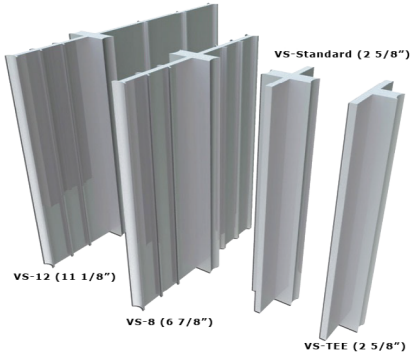

PVC Control Joints are vertical separations built into a concrete masonry wall to reduce restraint and permit longitudinal movement. They are located where cracking is likely to occur due to excessive tensile stress.

Lime

Order Code	Product Description	Packaged	Min Order
LIME	Lime 50 lb. Bag	per bag	1 bag



SUPER LIMOID® S Mason's Lime is a fine-grind, white, high-purity dolomitic lime, fully hydrated for immediate use. When properly combined with portland cement and sand, it creates a lime mortar having superior performance and ageless durability. SUPER LIMOID® S Mason's Lime complies with ASTM C207, Type S. Available in durable 3-ply, weather-resistant and poly-lined 50-lb. bags.

Fiber Forms

Order Code	Product Description	Packaged	Min Order
FF612	Fiber Form 6"x 12'	3 Nested	3 tubes
FF812	Fiber Form 8"x 12'	3 Nested	3 tubes
FF84	Fiber Form 8"x 4'	3 Nested	3 tubes
FF1012	Fiber Form 10"x 12'	3 Nested	3 tubes
FF1012R	Fiber Form 10"x 12'	3 Nested	3 tubes
FF104	Fiber Form 10"x 4'	3 Nested	3 tubes
FF1212	Fiber Form 12"x 12'	3 Nested	3 tubes
FF1212R	Fiber Form 12"x 12'	3 Nested	3 tubes
FF124	Fiber Form 12"x 4'	3 Nested	3 tubes
FF1412	Fiber Form 14"x 12' w/RAINGUARD	2 Nested	2 tubes
FF1612	Fiber Form 16"x 12'	2 Nested	2 tubes
FF1812	Fiber Form 18"x 12'	2 Nested	2 tubes
FF2012	Fiber Form 20" x 12'	per tube	1 tube
FF2412	Fiber Form 24"x 12'	2 Nested	2 tubes
FF3012	Fiber Form 30"x 12'	per tube	1 tube
FF3612	Fiber Form 36"x 12'	per tube	1 tube

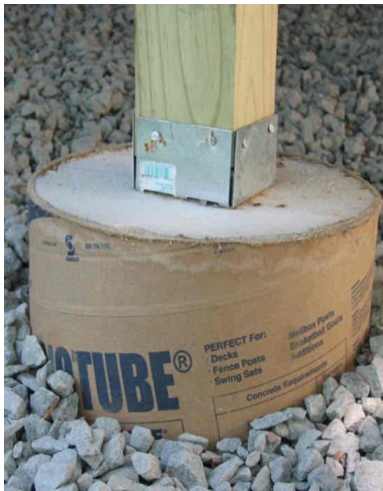

Fiber Forms Advantages

- Rain-resistant technology keeps wet weather from impacting your pour.
- Easier to setup and brace.
- Superior strength-to-weight properties prevent blowouts, during concrete form setting.
- More effective concrete form setting.
- Easy to cut and drill at the job site.
- No cleaning, reassembling, or return freight costs.
- Set and pour multiple columns at one time.

Applications

- Columns for residential and commercial buildings and other structures.
- Outdoor sign, light pole and fence-post bases.
- Footings and concrete column molds.
- Stub piers for elevated ramps.
- Flagstones and round steps.
- Theatrical and movie props.
- Can be used as large shipping tube
- Other concrete column applications.

Polyethylene Sheeting / "Visqueen" (4mil, 6mil or 10mil, Black or Clear)

Order Code	Product Description	Packaged	Min Order
PS1025B	10'x 25'x 004 BLACK Poly Sheeting	12/box	1 box
PS1025C	10'x 25'x 004 Clear Poly Sheeting	12/box	1 box
PS84B	8'x 100'x 004 BLACK Poly Sheeting	per roll	1 roll
PS84C	8'x 100'x 004 Clear Poly Sheeting	per roll	1 roll
PS86C	8'x 100'x 006 Clear Poly Sheeting	per roll	1 roll
PS104B	10'x 100'x 004 BLACK Poly Sheeting	per roll	1 roll
PS104C	10'x 100'x 004 Clear Poly Sheeting	per roll	1 roll
PS106B	10'x 100'x 006 BLACK Poly Sheeting	per roll	1 roll
PS106C	10'x 100'x 006 Clear Poly Sheeting	per roll	1 roll
PS124C	12'x 100'x 004 Clear Poly Sheeting	per roll	1 roll
PS126C	12'x 100'x 006 Clear Poly Sheeting	per roll	1 roll
PS164C	16'x 100'x 004 Clear Poly Sheeting	per roll	1 roll
PS166C	16'x 100'x 006 Clear Poly Sheeting	per roll	1 roll
PS2010C	20'x 100'x 010 Clear Poly Sheeting	per roll	1 roll
PS204B	20'x 100'x 004 BLACK Poly Sheeting	per roll	1 roll
PS204C	20'x 100'x 004 Clear Poly Sheeting	per roll	1 roll
PS206B	20'x 100'x 006 BLACK Poly Sheeting	per roll	1 roll
PS206C	20'x 100'x 006 Clear Poly Sheeting	per roll	1 roll
PS244C	24'x 100'x 004 Clear Poly Sheeting	per roll	1 roll
PS246C	24'x 100'x 006 Clear Poly Sheeting	per roll	1 roll
PS406B	40'x 100'x 006 BLACK Poly Sheeting	per roll	1 roll
PS406C	40'x 100'x 006 Clear Poly Sheeting	per roll	1 roll

Popular Sizes include:

20'x100'x4 mil (36/pallet)

20'x100'x6 mil (30/pallet)

10'x100'x4 mil (80/pallet)



Poly Sheeting is a fitting solution for everything from simple dust protection to heavy-duty construction projects. A strong, durable plastic that comes in a variety of sizes, 4 or 6 mil thickness, and black or clear colors to perfectly meet the requirements of your project. This heavy-duty sheeting is ideal for several different kinds of protection. Use it as a moisture barrier around insulation, for cement curing, for heavy dust and debris protection or even as a cover for tools and equipment.

- Strong and durable plastic sheet for multiple, heavy-duty uses
- Ideal for painting projects as a spray shield or drop cloth
- Use as a vapor barrier between drywall and insulation or under wood floors
- Can also be used to waterproof and as a dust cover
- Great for covering furniture or equipment during construction projects
- Perfect for landscaping applications as a mulch or rock bed
- Heavy-duty sheeting also works well for weather protection
- **5% Discount for Pallet Quantity Orders!**

Angle Iron (A-36 Structural Steel Angles, 4"x3"x1/4")

Order Code	Product Description	Packaged	Min Order
AI24	Angle Steel 24"x 4"x 3"x 1/4"	per angle	1 angle
AI240	Angle Steel 240"x 4"x 3"x 1/4"	per angle	1 angle
AI30	Angle Steel 30"x 4"x 3"x 1/4"	per angle	1 angle
AI36	Angle Steel 36"x 4"x 3"x 1/4"	per angle	1 angle
AI42	Angle Steel 42"x 4"x 3"x 1/4"	per angle	1 angle
AI48	Angle Steel 48"x 4"x 3"x 1/4"	per angle	1 angle
AI54	Angle Steel 54"x 4"x 3"x 1/4"	per angle	1 angle
AI60	Angle Steel 60"x 4"x 3"x 1/4"	per angle	1 angle
AI66	Angle Steel 66"x 4"x 3"x 1/4"	per angle	1 angle
AI72	Angle Steel 72"x 4"x 3"x 1/4"	per angle	1 angle
AI78	Angle Steel 78"x 4"x 3"x 1/4"	per angle	1 angle
AI84	Angle Steel 84"x 4"x 3"x 1/4"	per angle	1 angle
AI96	Angle Steel 96"x 4"x 3"x 1/4"	per angle	1 angle
AI108	Angle Steel 108"x 4"x 3"x 1/4"	per angle	1 angle
AI120	Angle Steel 120"x 4"x 3"x 1/4"	per angle	1 angle
AI144	Angle Steel 144"x 4"x 3"x 1/4"	per angle	1 angle



A36 Steel Angle is one of the most popular hot rolled, low carbon steel shapes used in manufacturing, fabrication, and repair projects. From trailers to truck beds, farm implements to construction equipment, steel angle has thousands of uses and applications. Its 90-degree angle shape adds strength and rigidity to any project for a lower price compared to other shapes and types of metal. It is easy to weld, cut, form and machine with the proper equipment and knowledge. Metals Depot stocks hundreds of sizes of steel angle that you can buy online in ready to ship precut or mill lengths or you can order just what you need custom cut to size in small or large quantity.

Aluminum Flashing

Order Code	Product Description	Packaged	Min Order
AF10	Aluminum Flashing 10"x 50'	per roll	1 roll
AF12	Aluminum Flashing 12"x 50'	per roll	1 roll
AF14	Aluminum Flashing 14"x 50'	per roll	1 roll
AF16	Aluminum Flashing 16"x 50'	per roll	1 roll
AF18	Aluminum Flashing 18"x50'	per roll	1 roll
AF20	Aluminum Flashing 20"x 50'	per roll	1 roll
AF24	Aluminum Flashing 24"x 50'	per roll	1 roll
AF28	Aluminum Flashing 28"x 50'	per roll	1 roll
AF6	Aluminum Flashing 6"x 50'	per roll	1 roll
AF8	Aluminum Flashing 8"x 50'	per roll	1 roll
AF57	Aluminum Step Flashing 5"x7"	500/box	1 box



Weather-proof your roof with 6-28 in. x 50 ft. Aluminum Drip Edge Flashing. The flashing is easy to bend, cut and shape for most roofing projects.

- Rust-resistant aluminum
- Protects and covers the edges of your roof
- Easy to bend, cut and shape for most roofing projects

Copper Flashing

Order Code	Product Description	Packaged	Min Order
CPR8	Yorkshield 106 PT 3oz.w/poly 8" x 20'	12/case	1 case
CPR12	Yorkshield 106 PT 3 oz.w/poly 12" x 20'	12/case	1 case
CPR1260	Yorkshield 106 PT 3oz.w/poly 12"x 60'*	12/case	1 case
CPR16	Yorkshield 106 PT 3oz.w/poly 16"x 20'	12/case	1 case
CPR8TS	YorkShield 106 TS 8" x 60' "Termite Spec"	12/case	1 case
CPR12TS	YorkShield 106 TS 12" x 60' "Termite Spec"	12/case	1 case



Unlike typical paper backings that wear away when they're wet, YorkShield 106 PT flashing has a new polymer backing (gray for easy identification) that effectively isolates galvanized joist hangers and fasteners from the decking - and the corrosive effects of ACQ and other treatments - so pressure treated decks look better and last longer.

- Compatible with ACQ and all other types of pressure treated wood / Two layers of self-sealing protection / Non-asphalt, 100% waterproof adhesive will not stain / Easy to form on-site by hand and no extra tools are required to shape it / Resists temperatures up to 275°F without separation / Use for decks, sills or windows

Lally Columns (and Beam/Saddle Plates)

Order Code	Product Description	Packaged	Min Order
DC4	Lally Columns 4"x 4'	12/skid	1 skid
DC5	Lally Columns 4" x 5'	12/skid	1 skid
DC6	Lally Columns 4"x 6'	12/skid	1 skid
DC6-6	Lally Columns 4"x 6'6"	12/skid	1 skid
DC7	Lally Columns 4" x 7'	12/skid	1 skid
DC7-3	Lally Columns 4" x 7'3"	12/skid	1 skid
DC7-6	Lally Columns 4"x 7'6"	12/skid	1 skid
DC7-9	Lally Columns 4" x 7'9"	12/skid	1 skid
DC8	Lally Columns 4" x 8'	12/skid	1 skid
DC8-6	Lally Columns 4' x 8'6"	12/skid	1 skid
DC8-9	Lally Columns 4" x 8'9"	12/skid	1 skid
DC9	Lally Columns 4" x 9'	12/skid	1 skid
DC9-6	Lally Columns 4"x 9'6"	12/skid	1 skid
DC9-9	Lally Columns 4" x 9'9"	12/skid	1 skid
DC10	Lally Columns 4" x 10'	12/skid	1 skid
DC12	Lally Columns 4" x 12' (12 per skid)	per column	1 column
DC14	Lally Columns 4" x 14' *(11ga.)	per column	1 column
DC16	Lally Columns 4" x 16' *(11ga.)	per column	1 column
DCHD8	Lally Columns 6"x 8' (5 per skid) <i>(HEAVY-DUTY 6" SIZE FOR BOLLARDS)</i>	per column	1 column



Lally Lock System

The Lally Lock System is made up of three components:

- 1. The new Lally Lock Column:** This column has the same strength as our old style but has an embedded fastening unit in the top of the column. The embedded fastening unit is made up of a 6" anchoring bolt threaded into a 1 1/4" coupling nut, which is embedded in the concrete. A welded steel disc finishes the top of the column.
- 2. The Lally Lock Cap Plates:** These plates are designed to accept a 1/2" bolt that is screwed into the coupling nut inside the embedded fastening unit.
- 3. The Lally Lock Base Plates:** The adjustable base set allows for 3" adjustment and is fastened to the column with concrete screws. The base plates with the ring prevents lateral displacement. The Lally Lock base plate is connected to the column with a concrete screw.

Why is the Lally Lock System superior to other concrete-filled columns?

- **No More Cutting** - Our columns are made in 3" increments and the adjustable base set has a 3" adjustment.
- **One Man Install** - Using our beam plate, you can hang the column with our exclusive key hole design.
- **No More Welding** - The cap plate is connected to the column using our embedded fastening unit. The base plate is connected with concrete screws.

Lally Column - Plates, Base Sets, & Other Accessories

Order Code	Product Description	Packaged	Min Order
DCABS	Adjustable Base Sets	5/box	1 box
DCBC3-4	3-1/8" Beam Plate (Welded Ring "Springfield")	10/box	1 box
DCBC3.5-4	3-5/8" Beam Plate (Welded Ring "Springfield")	10/box	1 box
DCBC4.5-4	4-5/8" Beam Plate (Welded Ring "Springfield")	10/box	1 box
DCBC5.25-4	5-3/8" Beam Plate (Welded Ring "Springfield")	10/box	1 box
DCBC6-4	6-1/8" Beam Plate (Welded Ring "Springfield")	10/box	1 box
DCBC7-4	7-1/8" Beam Plate (Welded Ring "Springfield")	10/box	1 box
DCBCN3	3-1/8" Beam Plate (Lally Lock)	10/box	1 box
DCBCN3.5	3-5/8" Beam Plate (Lally Lock)	10/box	1 box
DCBCN4.5	4-5/8" Beam Plate (Lally Lock)	10/box	1 box
DCBCN5.25	5-3/8" Beam Plate (Lally Lock)	10/box	1 box
DCBCN6	6-1/8" Beam Plate (Lally Lock)	10/box	1 box
DCBCN7	7-1/8" Beam Plate (Lally Lock)	10/box	1 box
DCSC3-4	3-1/8" Saddle Plate (Welded Ring)	8/box	1 box
DCSC3.5-4	3-5/8" Saddle Plate (Welded Ring)	8/box	1 box
DCSC4.5-4	4-5/8" Saddle Plate (Welded Ring)	8/box	1 box
DCSC5.25-4	5-3/8" Saddle Plate (Welded Ring)	6/box	1 box
DCSC6-4	6-1/8" Saddle Plate (Welded Ring)	6/box	1 box
DCSC7-4	7-1/8" Saddle Plate (Welded Ring)	6/box	1 box
DCSCN3	3-1/8" Saddle Plate (Lally Lock)	8/box	1 box
DCSCN3.5	3-5/8" Saddle Plate (Lally Lock)	8/box	1 box
DCSCN4.5	4-5/8" Saddle Plate (Lally Lock)	8/box	1 box
DCSCN5.25	5-3/8" Saddle Plate (Lally Lock)	6/box	1 box
DCSCN6	6-1/8" Saddle Plate (Lally Lock)	6/box	1 box
DCSCN7	7-1/8" Saddle Plate (Lally Lock)	6/box	1 box
DCSP	4" Standard Lally Column Plates	24/ring	1 ring
DCBITS	Ball End Bits for Lally Columns	20/tube	1 tube
DCBP	4" Lally Column Base Plates	12/box	1 box
DCCP	4" Lally Column Cap Plates	12/box	1 box
DCCC	Lally Column Cutter	per cutter	1 cutter

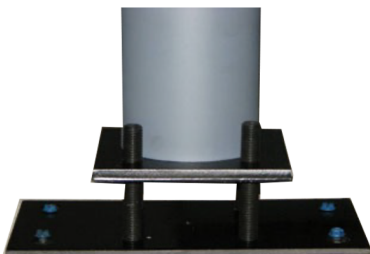

Adjustable Base Plate

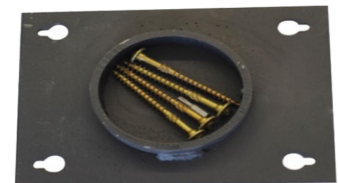

**Welded Ring Beam Plate
& Screws Included**

Section 2: Foundation Doors, Air & Flood Vents, Windows, and Area Walls

Foundation Vents

Order Code	Product Description	Packaged	Min Order
AFVBL	Air Vent Automatic Foundation Vent BLACK 16x8	per vent	1 vent
AFVGR	Air Vent Automatic Foundation Vent GRAY 16x8	per vent	1 vent
VC168	Jalco Aluminum Foundation Vent 16x8	12/box	1 box
ALSL	Jalco Aluminum SLIDER Foundation Vent 16x8	12/box	1 box
BV11	Vestal Aluminum Brick Vent (1-Brick)	12/box	1 box
BV12	Vestal Aluminum Brick Vent (Double-Brick)	6/box	1 box
L189	Vestal Louvered Foundation Vent 16x8 GALV.	12/box	1 box
PLSLGR	Plastic Slider Foundation Vent 16x8	12/box	1 box
PNPFVF8	Duo PNP Automatic Foundation Vent (7-7/8", N8)	per vent	1 vent



**PLACE-N-POUR
P-N-P AUTOMATIC
FOUNDATION VENT**

Automatic Foundation Vents have a bi-metal coil to open and close automatically without electricity. When the temperature reaches 70°F the vent is fully opened to provide fresh intake air, and fully closes at approximately 40°F to conserve energy and protect pipes.

- The **"Air Vents"** are easily installed using screws, or screw anchors or with retaining clips. Both are included with the vents. No mortar is required for installation.
- The **"P-N-P Vents"** are Fusion Welded, Maintenance Free, All Vinyl Frame Construction, Chambered Profile for Strength, Rigidity and Increased Thermal Performance, Contoured Exterior Surface for Added Concrete Adhesion, Have a Triple Duty Reinforcement, which Resists the Weight of the Pour, Provides Full-face Nailer to Secure into Form and Protects the Vent (along with 3 Mil Blue Film Protects Both Sides of Every Unit), and Multilingual Labeling Designating TOP and OUTSIDE

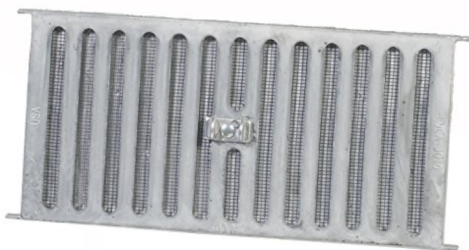

VC168 (J019) Aluminum Vent

- Cast Aluminum
- Single Slide
- 3/4" Scalloped Lintel
- **Popular In South NJ**



ALSL Aluminum Slider Vent

- Overall: 17"W x 7.8"H x 1.4"D
- 45 sq. in. free area
- Will ventilate 33 sq. ft
- Adjustable sliding damper
- #8 mesh screen
- **Popular in NY, Central & North NJ, and PA**

Foundation Flood Vents

Order Code	Product Description	Packaged	Min Order
FVG	Flood Flap - Certified Vent GRAY w/Flange	per vent	1 vent
FVI	Flood Flap - Flood Vent Insulator Insert	per vent	1 vent
FVW	Flood Flap - Certified Vent WHITE w/Flange	per vent	1 vent



Flood Flap Flood Vent

Flood Flaps® Multi-Purpose Series vents are FEMA compliant flood vents certified to provide flood protection and air ventilation. These models are perfectly designed for an enclosure or crawlspace in a flood plain that desires natural air while still providing efficient flood relief when necessary. The patented grill remains closed and secure until forced open by flood waters, allowing water to enter or exit the enclosed area. These automatic foundation flood vents are also FEMA/NFIP compliant. Flood Flaps Multi-Purpose Series flood vents are the most affordable ICC-ES certified flood vents available and perfect for owners looking to bring their existing structure or new construction into flood code compliance. Unmatched Value...an ICC-ES certified, engineered FEMA compliant flood vents covering 220 sq. ft. for far less cost

Vinyl Basement Windows – Pour In Place & Hopper Styles

Order Code	Product Description	Packaged	Min Order
DUO3216HOPN	Duo Vinyl PNP Hopper Window 32"x16"	per window	1 window
DUO3220HOPN	Duo Vinyl PNP Hopper Window 32"x20"	per window	1 window
DUO3224HOPN	Duo Vinyl PNP Hopper Window 32"x24"	per window	1 window
DUO3220SLDN10	Duo Vinyl PNP Slider Window 32"x20"	per window	1 window
DUOA3215	Duo Aristoclass Vinyl Window 32"x15"	per window	1 window
DUOA3219	Duo Aristoclass Vinyl Window 32"x19"	per window	1 window
DUOA3223	Duo Aristoclass Vinyl Window 32"x23"	per window	1 window
DUOC3214	Duo Competitor Vinyl Window 32"x14"	per window	1 window
DUOC3218	Duo Competitor Vinyl Window 32"x18"	per window	1 window
DUOC3222	Duo Competitor Vinyl Window 32"x22"	per window	1 window



Duo Vinyl Basement Windows

- Duo windows feature "All Vinyl Construction" for a maintenance-free experience for the homeowner
- All windows are built with energy efficient 3/4" insulated glass
- True sloped sill for efficient water removal
- No tool sash removal
- Fully weather-stripped → 2X Sash Top & Sides & 3X Sash Bottom

Foundation Access Doors

Order Code	Product Description	Packaged	Min Order
A2424	Vestal Foundation Access Door 24"W x 24"H	per door	1 door
A3216	Vestal Foundation Access Door 32"W x 16"H	per door	1 door
A3224	Vestal Foundation Access Door 32"W x 24"H	per door	1 door
A3232	Vestal Foundation Access Doors 32"x 32"	per door	1 door
A3240	Vestal Foundation Access Door 32"W x 40"H	per door	1 door

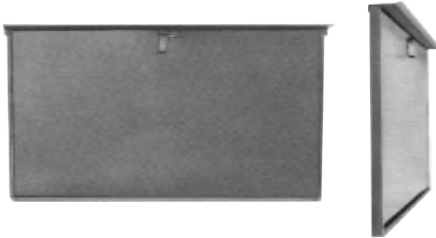

Foundation Access Doors are made from heavy gauge steel, all welded construction. Built-in lintel attached. Positive latch made to accept padlock. Door size is stenciled on each door. Primed with black corrosion resistant paint. Made in USA by Vestal.

Bilco Doors

Order Code	Product Description	Packaged	Min Order
BILO	Bilco Door Size "O"	per door	1 door
BILB	Bilco Door Size "B"	per door	1 door
BILBP	Bilco "B" Door Powder Coated	per door	1 door
BILC	Bilco Door Size "C"	per door	1 door
BILCP	Bilco "C" Door Powder Coated	per door	1 door
BILSL	Bilco Door Size "SL"	per door	1 door
BILUC	Bilco Door ULTRA Size "C"	per door	1 door
BILBR1	Bilco BR-1 Sloped Wall Door	per door	1 door
BILBR2	Bilco BR-2 Sloped Wall Door	per door	1 door
BILBR3	Bilco BR-3 Sloped Wall Door	per door	1 door



Classic Primer Bilco Doors

Add the convenience of direct basement access and get the full use of your home. Bilco basement doors allow homeowners to add code-compliant living space or storage areas to their home. Large items such as games tables and furniture for finished areas, or pool supplies and patio furniture for storage areas, move easily through the wide opening of a Bilco door.



Powder Coated Doors

Bilco Classic Series steel basement doors are now available with a factory-applied polyester powder coat finish. The polyester resin provides a durable, weather-resistant coating. Cured at higher temperatures than most wet coatings, the result is a tougher and chip-resistant coating, providing both a decorative and protective finish.

Finish		Size and Model Numbers			
		B	C	O	SL
Primer*		SZ BG	SZ CG	SZ OG	SZ SLG
Powder Coat	White	SZ BGPC1	SZ CGPC1	X	X
	Sandstone	SZ BGPC2	SZ CGPC2	X	X
	Gray	SZ BGPC7	SZ CGPC7	X	X
	Brick	SZ BGPC4	SZ CGPC4	X	X
	Black	SZ BGPC5	SZ CGPC5	X	X
	Green	SZ BGPC6	SZ CGPC6	X	X



Ultra Series Doors

Ultra Series doors provide safe and code-compliant basement access, weather-tight performance and easy operation — all with virtually no maintenance. The Ultra Series door will never rust, rot or need painting. It's simulated wood texture and pleasing driftwood color will complement the exterior of any home and the interchangeable side panel inserts allow homeowners to easily add light or ventilation to their basement areaway.

Bilco Door Extensions

Order Code	Product Description	Packaged	Min Order
BILX6	Bilco Door Extension 6"	per extension	1 extension
BILX6P	Bilco Door Extension 6" Powder Coated	per extension	1 extension
BILX12	Bilco Door Extension 12"	per extension	1 extension
BILX12P	Bilco Door Extension 12" Powder Coated	per extension	1 extension
BILX18	Bilco Door Extension 18"	per extension	1 extension
BILX18P	Bilco Door Extension 18" Powder Coated	per extension	1 extension
BILX24	Bilco Door Extension 24"	per extension	1 extension
BILX24P	Bilco Door Extension 24" Powder Coated	per extension	1 extension
BILX30	Bilco Door Extension 30"	per extension	1 extension
BILX30P	Bilco Door Extension 30" Powder Coated	per extension	1 extension
BILUX6	Bilco ULTRA 6" Extension	per extension	1 extension
BILUX12	Bilco ULTRA 12" Extension	per extension	1 extension
BILBR1X6	Bilco BR-1 Sloped Wall Door Extension 6"	per extension	1 extension
BILBR1X12	Bilco BR-1 Sloped Wall Door Extension 12"	per extension	1 extension
BILBR1X18	Bilco BR-1 Sloped Wall Door Extension 18"	per extension	1 extension
BILBR2X6	Bilco BR-2 Sloped Wall Door Extension 6"	per extension	1 extension
BILBR2X12	Bilco BR-2 Sloped Wall Door Extension 12"	per extension	1 extension
BILBR2X18	Bilco BR-2 Sloped Wall Door Extension 18"	per extension	1 extension
BILBR3X6	Bilco BR-3 Sloped Wall Door Extension 6"	per extension	1 extension
BILBR3X12	Bilco BR-3 Sloped Wall Door Extension 12"	per extension	1 extension
BILBR3X18	Bilco BR-3 Sloped Wall Door Extension 18"	per extension	1 extension

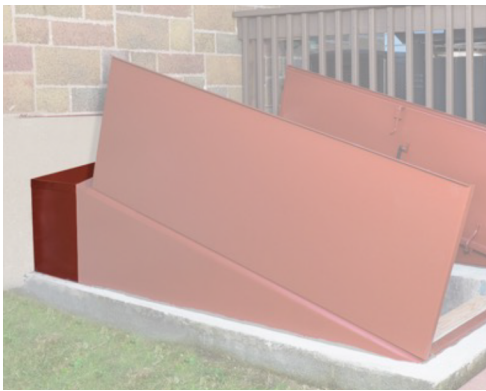

Extensions are available to increase the door length of Bilco basement doors. Two or more can be mounted back to back to increase the door length to virtually any size.

For the Classic Series, steel extension panels are supplied with a primer finish. A factory applied powder coat paint finish option is also available.



Bilco Door Locks and Stair Stringers

Order Code	Product Description	Packaged	Min Order
BILL	Bilco Door Lock	per lock	1 lock
BILLP	Bilco Lock Powder Coated	per lock	1 lock
BILSB	Bilco Stair Stringer Size "B"	per stringer	1 stringer
BILSC	Bilco Stair Stringer Size "C"	per stringer	1 stringer
BILSE	Bilco Stair Stringer Extension "E"	per stringer	1 stringer
BILSO	Bilco Stair Stringer Size "O"	per stringer	1 stringer
BILSSL	Bilco Stair Stringer Size "SL"	per stringer	1 stringer



Stair Stringer

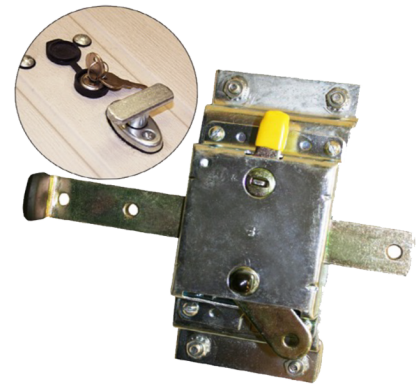

Door Lock

Bilco Foundation Plates

Order Code	Product Description	Packaged	Min Order
BILFP5	Bilco Foundation Plate 5"	per plate	1 plate
BILFP8	Bilco Foundation Plate 8"	per plate	1 plate
BILFP11	Bilco Foundation Plate 11"	per plate	1 plate
BILFP14	Bilco Foundation Plate 14"	per plate	1 plate



Bilco StackWel and ScapeWel Window Wells

Order Code	Product Description	Packaged	Min Order
BILSTW48	Bilco StakWel 21" High	per well	1 well
BILSTWC48	Bilco StakWel Clear Cover	per cover	1 cover
BILSCW4048-42	Bilco ScapeWel Window Well 4048-42	per well	1 well
BILSCW4048-54	Bilco ScapeWel Window Well 4048-54	per well	1 well
BILSCW4862-42	Bilco ScapeWel Window Well 4862-42	per well	1 well
BILSCW4862-54	Bilco ScapeWel Window Well 4862-54	per well	1 well
BILSCW4862-66	Bilco ScapeWel Window Well 4862-66	per well	1 well
BILSCWC4042-C	Bilco ScapeWel Cover 4042-C	per cover	1 cover
BILSCWC4054-C	Bilco ScapeWel Cover 4054-C	per cover	1 cover
BILSCWC4842-C	Bilco ScapeWel Cover 4842-C	per cover	1 cover
BILSCWC4854-C	Bilco ScapeWel Cover 4854-C	per cover	1 cover
BILSCWC4866-C	Bilco ScapeWel Cover 4866-C	per cover	1 cover
BILSCWX3019-42	Bilco ScapeWel Extension 3019-42	per extension	1 extension
BILSCWX3019-54	Bilco ScapeWel Extension 3019-54	per extension	1 extension
BILSCWX3019-66	Bilco ScapeWel Extension 3019-66	per extension	1 extension



ScapeWel Planter Design

ScapeWel's add natural daylight and meets building code requirements for emergency egress in finished basement areas. Innovative step design aids egress and can be landscaped with plants or flowers for added visual enhancement. ScapeWEL features maintenance free high-density polyethylene construction and is available in a number of sizes to accommodate virtually any foundation height or window dimension.



StakWel Modular Design

StakWel's Modular system is one of the fastest and least expensive ways to add code-compliant emergency egress to any basement area. Simply "stack" the modules (4 module stack shown) to accommodate your foundation height and add natural daylight to your finished basement. StakWEL features a unique "Grip/Step" design to aid emergency egress and provides corrosion resistant performance at "steel-like" window well prices.

Galvanized Area Walls

Order Code	Product Description	Packaged	Min Order
RC12	Area Wall Galv. 37"W X 12"H	4/bundle	1 bundle
RC18	Area Wall Galv. 37"W X 18"H	4/bundle	1 bundle
RC24	Area Wall Galv. 37"W X 24"H	3/bundle	1 bundle
RC30	Area Wall Galv. 37"W X 30"H	3/bundle	1 bundle
RC36	Area Wall Galv. 37"W X 36"H	3/bundle	1 bundle
FA16	Area Wall Galv. (VENT WELL) 20"W X 12"H	6/bundle	1 bundle

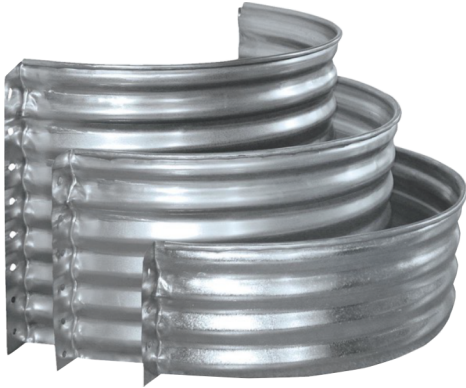

Galvanized Foundation Area Wall helps keep dirt and debris away from your basement vent or window. The 12 inch high metallic area wall has pre-drilled holes for hassle-free installation directly to your house wall. The wall is galvanized for resistance to rust and corrosion.

*** Please call for quotes on different sizes & shapes of Area Wall**

Section 3: Expansion Joints / Homasote Boards / Cedar Louvers

Fiber Expansion Joint

Order Code	Product Description	Packaged	Min Order	Per Skid
FXJ123	Fiber Expansion Joint 1/2"x 3"x 10'	10/bundle	1 bundle	1280 pieces
FXJ12312	Fiber Expansion Joint 1/2"x 3.5"x 10'	10/bundle	1 bundle	1120 pieces
FXJ124	Fiber Expansion Joint 1/2"x 4"x 10'	10/bundle	1 bundle	960 pieces
FXJ126	Fiber Expansion Joint 1/2"x 6"x 10'	10/bundle	1 bundle	640 pieces
FXJ128	Fiber Expansion Joint 1/2"x 8"x 10'	10/bundle	1 bundle	480 pieces
FXJ1212	Fiber Expansion Joint 1/2"x 12"x 10'	special order - skid minimum		
FXJ1216	Fiber Expansion Joint 1/2" x 16" x 10'	special order - skid minimum		
FXJ1218	Fiber Expansion Joint 1/2"x 18"x 10'	special order - skid minimum		
FXJ1248	Fiber Expansion Joint 1/2"x 48"x 10'	1 sheet	1 sheet	80 sheets



Fiber Expansion Joint

Fiber Expansion Joint is composed of cellular fibers securely bonded together and uniformly saturated with asphalt to assure longevity. Wherever a cost-effective joint filler is required, Fiber meets the need. Manufactured and marketed by W. R. Meadows since the early 1930s, Fiber Expansion Joint is backed by over 80 years of proven application experience. It is versatile, resilient, flexible and non-extruding. When compressed to half of its original thickness, it will recover to a minimum of 70% of its original thickness. Fiber Expansion Joint will not deform, twist, or break with normal on-the-job handling.

Homex Expansion Joint

Order Code	Product Description	Packaged	Min Order	Per Skid
HXJ123	HOMEX Exp. Joint 1/2"x 3-1/2"x 10'	15/bundle	1 bundle	840 pieces
HXJ124	HOMEX Exp. Joint 1/2"x 4"x 10'	15/bundle	1 bundle	720 pieces
HXJ126	HOMEX Exp. Joint 1/2"x 6"x 10'	12/bundle	1 bundle	576 pieces



Homex Expansion Joint

Homex 300 is a unique material that does double duty as light duty forming material for walkways, patios pool aprons and driveways and as an expansion joint where masonry or concrete walls meet outside aprons, walks, patios or steps. Eco-friendly and helps projects earn LEED points!

Rubber Expansion Joint

Order Code	Product Description	Packaged	Min Order	Per Skid
REX123	Rubber Expansion Joint 1/2"x 3"x 10'	10/bundle	1 bundle	3200 pieces
REX12312	Rubber Expansion Joint 1/2"x 3.5"x 10'	10/bundle	1 bundle	2800 pieces
REX124	Rubber Expansion Joint 1/2"x 4"x 10'	10/bundle	1 bundle	2400 pieces
REX126	Rubber Expansion Joint 1/2"x 6"x 10'	10/bundle	1 bundle	1600 pieces



Rubber Expansion Joint

J.D. Russell's REFLEX® Rubber Expansion Joint Material for Concrete is a processed board product formed by blending granular crumb rubber derived from discarded tires and various low density polymer components. Pre-molded under heat and pressure, REFLEX® is far more durable than current alternatives.

X-Foam Polypropylene Joint Filler

Order Code	Product Description	Packaged	Min Order	Per Skid
NEX123	Polypropylene Joint 1/2" X 3" X 10'	10/bundle	1 bundle	1280 pieces
NEX12312	Polypropylene Joint 1/2" X 3-1/2" X 10'	10/bundle	1 bundle	1120 pieces
NEX124	Polypropylene Joint 1/2" X 4" X 10'	10/bundle	1 bundle	960 pieces
NEX126	Polypropylene Joint 1/2" X 6" X 10'	10/bundle	1 bundle	640 pieces
NEX124810	Polypropylene Joint 1/2" X 48" X 10'	10/bundle	1 bundle	80 sheets
NEX34410	Polypropylene Joint 3/4" X 4" X 10'	10/bundle	1 bundle	720 pieces
NEX346	Polypropylene Joint 3/4" X 6" X 10'	10/bundle	1 bundle	480 pieces
NEXCUT	1/2" X 3" X 10'			Polypropylene CUTTER



Polypropylene Joint Filler Plank and Sheet

Polypropylene is an expansion joint filler product used in residential, commercial, civil, municipal and industrial applications. It is easy to handle and extends the service life of concrete by acting as an insulator for contraction and expansion joints. It can be used with hot-pour or cold-applied sealants. Polypropylene prevents three-sided adhesion and can be used without a bond breaker. It also has no odor or sticky residue and is resistant to oils, gas, salts and other chemicals.

Mortex Control Joint

Order Code	Product Description	Packaged	Min Order
MCJ	Mortex Control Joint - WHITE - 12'	33/box	1 box
MCJC	Mortex Control Joint - COLOR - 12'	33/box	1 box
MEB	Mortex Expansion Base – WHITE - 12'	36/box	1 box

**** See drainage section for Drain Rite, which can also work as an expansion joint****

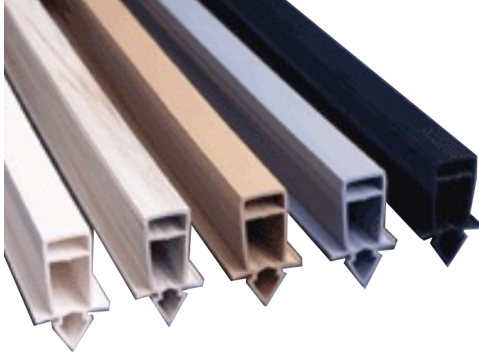

Control Joint™ is a PVC lineal contractual joint system for concrete crack control. Control Joint encourages the concrete to crack in a designated acceptable manner. Control Joint has excellent weatherability. It is virtually unaffected by chlorine and pool chemicals.

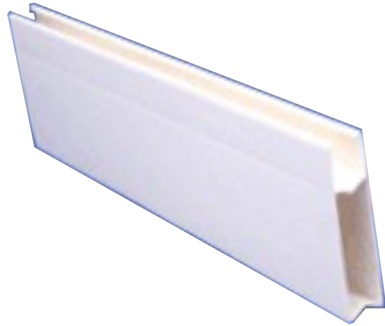

Expansion Base simply snaps to the Control Joint to create a full expansion joint. Good concrete practices necessitate the periodic use of full expansion as well as contractual joints.

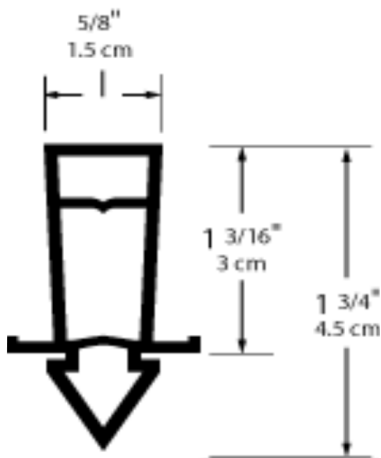

Expanded Poly Expansion Joint with Peel

Order Code	Product Description	Packaged	Min Order
STRIP123	Exp Poly Exp Joint 1/2"x 3"x 50' w/ 1/2"peel (16/bag)	by roll	1 roll
STRIP124	Exp Poly Exp Joint 1/2"x 4"x 50' w/ 1/2"peel (12/bag)	by roll	1 roll
STRIP126	Exp Poly Exp Joint 1/2"x 6"x 50' w/ 1/2"peel (8/bag)	by roll	1 roll



Expanded Poly Expansion Joint with 1/2" Peel
 DECK-O-FOAM expansion joint filler is a flexible, lightweight, non-staining, polyethylene, closed-cell expansion joint filler. It is a chemical-resistant, ultraviolet stable, non-absorbent, low density, cost-effective, compressible foam that offers an extended service life in both interior and exterior applications.

Snap-Cap

Order Code	Product Description	Packaged	Min Order
SNAP	Snap-Cap 1/2"x 10'	100/box	1 box

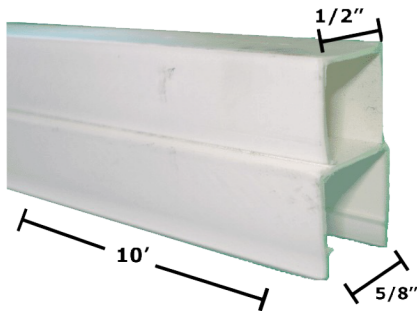

Snap Cap - Expansion Joint Cap

SNAP-CAP provides a time and cost-saving method for forming straight, uniform and debris-free joints of the proper configuration, ready to seal. The top of SNAP-CAP pulls free and can be discarded. The exposed concrete surfaces assure balanced adherence to the sides. It is ideal for both horizontal and vertical concrete projects.

Homasote Board Products

Order Code	Product Description	Packaged	Min Order
H4812440	Homasote 440 Board 1/2"x 4'x 8'	60/skid	1 skid
H4858440	Homasote 440 Board 5/8"x 4'x 8'	54/skid	1 skid
HHP2412	Homasote 440 Handy Panel 1/2"x4'x4'	60/skid	1 skid
H44CB	Homasote Comfort Base 1/2"x 4'x 4'	60/skid	1 skid
H48DW	Homasote Design Wall 1/2"x 4'x 8' "choose color	60/skid	1 skid
H48NC	Homasote Nova Cork Panel 1/2"x4'x8'''	72/skid	1 skid



Homasote 440 Sound Barrier Board

Independently lab tested and time-proven in millions of square feet of residential and commercial structures, 440 SoundBarrier® is a special-density, structural board made from 100 percent environmental Homasote® cellulose fiber, a homogeneous composition manufactured with uniformly distributed protection against termites, rot and fungi and resistance to moisture. It also insulates, with twice the R-value of wood. Made with FSC® certified material.

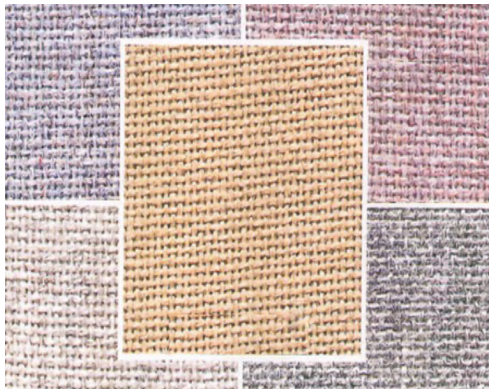

DesignWall panels are elegant, prefinished interior paneling composed of Guilford of Maine® FR 701 fabric. They are versatile, tackable, sound-deadening panels, and designed for a range of applications, from family rooms and children's bedrooms to schoolrooms and business offices - anywhere the rich look of a fabric with a fully tackable wall would be appreciated.



NovaCork panels are ultra-tackable interior panels that are completely finished and require no surface treatment. The top layer is a sheet of cork "planks refuses" making these panels perfect for homes, schools, offices, and hospitals, wherever large tackable bulletin-board areas are needed. Energy-saving, NovaCork panels are noise-deadening, while providing extra insulation when used to panel peripheral walls or ceilings.

Section 4: Fireplaces, Dampers, and Accessories

Fireplaces

Order Code	Product Description	Packaged	Min Order
VEST30	Vestalaire 30" Fireplace "UL" Label	per piece	1 piece
VEST34	Vestalaire 34" Fireplace "UL" Label	per piece	1 piece
VEST38	Vestalaire 38" Fireplace "UL" Label	per piece	1 piece
VEST42	Vestalaire 42" Fireplace "UL" Label	per piece	1 piece
VEST50	Vestalaire 50" Fireplace "UL" Label	per piece	1 piece



Vestalaire Circulator Fireplace

Vestalaire Circulator is a heat-circulating firebox that when vented and used with electric fans, allows the fireplace to give off much more heat.

Vestal Fireplace Accessories

For over 65 years, Vestal Manufacturing has provided quality USA-made gray iron castings to our customers. American craftsmanship and technology, backed by a focus on quality, are integral parts of any Vestal casting. Our goal is to produce superior products on a timely schedule, at the most reasonable cost.

Ash Dumps & Caddys, Cleanout Doors, Airkits, Vents, Etc

Order Code	Product Description	Packaged	Min Order
C459	Vestal Cast Iron Ash Dump 4.5"x 9"	12/box	1 box
AD459	Vestal STEEL Ash Dump 4.5"x 9"	12/box	1 box
C459H	Vestal Cast Iron Ash Dump 4.5"x 9" W/HOLES	12/box	1 box
C88	Vestal Cast Iron Clean Out Door 8"x 8"	6/box	1 box
CO88	Vestal STEEL Clean Out Door 8"x 8"	6/box	1 box
C1212	Vestal Cast Iron Clean Out Door 12"x 12"	per door	1 door
OA	Vestal Outside Airkit	per kit	1 kit
MOK	Vestal Masonry Outside Airkit (SIDE)	per kit	1 kit
MOKR	Vestal Masonry Outside Airkit (REAR)	per kit	1 kit
F-9	Vestal Electric Fan #9 (Bottom Air Only)	per fan	1 fan
F10	Vestal Electric Fan #10 (Circulator Enclosed Motor)	per fan	1 fan
9GRILLE	Vestal #9 Grille	per fan	1 fan
DS-9	Vestal Grille & Duct System	per system	1 system
AC95	Vestal AC Cast Iron Ash Caddy "Hutch AC95"	per caddy	1 caddy
KH	Vestal Keeper Hasp for CC1 Poker Control	per hask	1 hask
BC813	Vestal SC-2 Adjustable Brick Clamps "Hutch BC813"	per clamp	1 clamp
AIRBRICK	Vestal Cast Iron Air/Brick Vent "V364"	per vent	1 vent
CR1	Vestal Rotary Control for CI Damper	per control	1 control
CC1	Vestal Cast Iron Poker Control w/ Hasp	per poker	1 poker
BV11 or BV12	Aluminum Brick Vents (Single AL-1 / Double AL-2)	12/box	1 box

Dampers and Damper Accessories

Order Code	Product Description	Packaged	Min Order
CC24	Vestal Cast Iron Damper 24"	per damper	1 damper
CC30	Vestal Cast Iron Damper 30"	per damper	1 damper
CC33	Vestal Cast Iron Damper 33"	per damper	1 damper
CC36	Vestal Cast Iron Damper 36"	per damper	1 damper
CC36L	Vestal Cast Iron Damper (LID ONLY) 36"	per lid	1 lid
CC42	Vestal Cast Iron Damper 42"	per damper	1 damper
CC42L	Vestal Cast Iron Damper (LID ONLY) 42"	per lid	1 lid
CC48	Vestal Cast Iron Damper 48"	per damper	1 damper
CC54	Vestal Cast Iron Damper 54" (DOUBLE LID)	per damper	1 damper
CC60	Vestal Cast Iron Damper 60" (DOUBLE LID)	per damper	1 damper
CC72	Vestal Cast Iron Damper 72" (DOUBLE LID)	per damper	1 damper
H132	Vestal Multi-Universal Damper Steel 33"x 20"	per damper	1 damper
H136	Vestal Multi-Universal Damper Steel 36"x 20"	per damper	1 damper
H140	Vestal Multi-Universal Damper Steel 42"x 20"	per damper	1 damper
H148	Vestal Multi-Universal Damper Steel 48"x 24"	per damper	1 damper
ET913	Sealtight Energy Top Damper 9"x 13"	per damper	1 damper
ET1313	Sealtight Energy Top Damper 13"x 13"	per damper	1 damper
ST99	Sealtight Top-Mount Damper 8"x 8"	per damper	1 damper
ST913	Sealtight Top-Mount Damper 9"x 13"	per damper	1 damper
ST12R	Sealtight Top Mount Damper 12" (ROUND)	per damper	1 damper
ST1313	Sealtight Top Mount Damper 13"x 13"	per damper	1 damper
ST1318	Sealtight Top-Mount Damper 13"x 18"	per damper	1 damper
ST1717	Sealtight Top-Mount Damper 18"x 18"	per damper	1 damper
STEX50	Sealtight Damper Extension Cable 50'	per cable	1 cable
LDA	Sealtight Damper Adhesive 3oz. Silicon	per piece	1 piece
LDHP	Sealtight Damper Hardware Package	per package	1 package



Vestal Cast Iron Damper



Sealtight Top-Mount Damper

Chimney Flue Caps & Legs

Order Code	Product Description	Packaged	Min Order
FCG88	Flue Cap GALV. 8 x 8	per cap	1 cap
FCG813	Flue Cap GALV. 8 x 13	per cap	1 cap
FCG817	Flue Cap GALV. 8 x 17	per cap	1 cap
FCG1313	Flue Cap GALV. 13 x 13	per cap	1 cap
FCG1317	Flue Cap GALV. 13 x 17	per cap	1 cap
FCG1717	Flue Cap GALV. 17 x 17	per cap	1 cap
FCS88	Flue Cap STAINLESS 8 x 8	per cap	1 cap
FCS813	Flue Cap STAINLESS 8 x 13	per cap	1 cap
FCS817	Flue Cap STAINLESS 8 x 17	per cap	1 cap
FCS1313	Flue Cap STAINLESS 13 x 13	per cap	1 cap
FCS1317	Flue Cap STAINLESS 13 x 17	per cap	1 cap
FCS1717	Flue Cap STAINLESS 17 x 17	per cap	1 cap
LEGJ	Slip In Legs For Flue Caps GALV	per set	1 set
LEGJS	Slip In Legs For Flue Caps STAINLESS	per set	1 set



Hy-C Single-Flue Galvanized Caps feature high temperature, rust resistant, satin smooth black finish, along with a durable build that protects chimneys against snow, rain and animals. Each cap is constructed of a 24-gauge lid with 18-gauge 3/4" galvanized steel, 6.5" high mesh. For added strength, the base of the cap is constructed of 14-gauge galvanized steel and the lower edges of the mesh are folded inward.

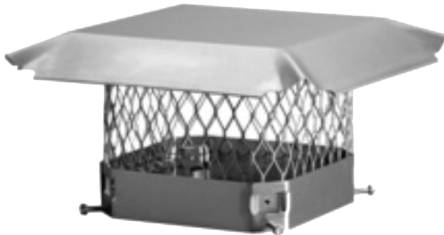

Hy-C Single Flue Stainless Steel Chimney Caps are constructed of 304 Stainless Steel. The slotted hex-head mounting bolts are indented into the base to give the cap an even, secure grip against the flue tile.

Fire Brick & Clay

Order Code	Product Description	Packaged	Min Order
FB8	Fire Brick 8-1/4"x 4"x 2-1/2"	567/skid	1 skid
FB8S	Fire Brick SPLITS 8-1/4"x 4"x 1-1/4"	928/skid	1 skid
FB9	Fire Brick 9"x 4.5"x 1.25"	500/skid	1 skid
FB8R	RED Fire Brick 8-1/4"x 4"x 2-1/2"	567/skid	1 skid
FB8RS	RED Fire Brick SPLITS 8-1/4"x 4"x 1-1/4"	928/skid	1 skid
CLAY	Fire Clay 50# Bag	per bag	1 bag



Fire Brick

Colors: Red or Buff
 Sizes: Full or Splits

Refractory Mortar

Order Code	Product Description	Packaged	Min Order
HEAT50	Heat Stop 50lb.pail (WET)	per pail	1 pail
HEAT50D	Heat Stop 50 lb. bag (DRY)	per bag	1 bag
HEATD	Heat Stop 10lb. can (DRY)	per can	1 can
HEATS	Heat Stop 15lb. can (WET)	per can	1 can



These dry-mix refractory mortars are made from high temperature cements and carefully selected aggregates that will not expand or tear the mortar apart when heated. Once dried, these products are non-water soluble and more acid resistant than any other type of product used in these applications.

Clay Flue Rings

Order Code	Product Description	Packaged	Min Order
SUP412CFR	Clay Flue Ring 4"x 12"	per ring	1 ring
SUP512CFR	Clay Flue Ring 5"x 12"	per ring	1 ring
SUP612CFR	Clay Flue Ring 6"x 12"	per ring	1 ring
SUP712CFR	Clay Flue Ring 7"x 12"	per ring	1 ring
SUP812CFR	Clay Flue Ring 8"x 12"	per ring	1 ring
SUP912CFR	Clay Flue Ring 9"x 12"	per ring	1 ring
SUP1012CFR	Clay Flue Ring 10"x 12"	per ring	1 ring
SUP1212CFR	Clay Flue Ring 12"x 12"	per ring	1 ring

Clay Flu Liners (Plus Camel Back Coping & Hex Drain Tile)

Order Code	Product Description	Packaged	Min Order
SUP813RCF	Clay Flue Liners 8-1/2"x 13"x 24"	60/skid	1 skid
SUP818RCF	Clay Flue Liners 8-1/2"x 18"	36/skid	1 skid
SUP88RCF	Clay Flue Liners 8-1/2"x 8-1/2"x 24"	72/skid	1 skid
SUP1313RCF	Clay Flue Liners 13"x 13"x 24"	40/skid	1 skid
SUP1318RCF	Clay Flue Liners 13"x 18"x 24"	24/skid	1 skid
SUP1616RCF	Clay Flue Liners 16"x 16"x 24"	24/skid	1 skid
SUP1818RCF	Clay Flue Liners 18"x 18"x 24"	18/skid	1 skid
SUP2020RCF	Clay Flue Liners 20"x 20"x 24"	12/skid	1 skid
COPCB9	Camel Back Coping 9" 100 ft/Pallet	25 pieces	1 skid
COPCB13	Camel Back Coping 13" 60 ft/Pallet	15 pieces	1 skid
HEXDT	4"x 12"Clay Hex Drain Tile	per tile	1 tile



Section 5: Wheelbarrows, Shovels and Various Hand Tools

Wheelbarrows

Order Code	Product Description	Packaged	Min Order
M5	Jackson M5 Wheelbarrow 5 c.f.	per w.b.	1 w.b.
M6	Jackson M6 Wheelbarrow 6 c.f.	per w.b.	1 w.b.
M6FF	Jackson M6 Wheelbarrow 6 c.f. W/FLAT FREE	per w.b.	1 w.b.
M6TC	Jackson M6 Wheelbarrow (Total Control) 6 c.f.	per w.b.	1 w.b.
M11	Jackson M11 Wheelbarrow 5.75 c.f.	per w.b.	1 w.b.
MP575	Jackson POLY Wheelbarrow 5.75 c.f.	per w.b.	1 w.b.
MP575FF	Jackson POLY Wheelbarrow 5.75 c.f. w/FLAT FREE	per w.b.	1 w.b.
MP575W	Jackson POLY Wheelbarrow 5.75 c.f. w/WIDE TIRE	per w.b.	1 w.b.
BP8	Jackson POLY Wheelbarrow 8 c.f. DUAL WHEEL	per w.b.	1 w.b.
BP10	Jackson POLY Wheelbarrow 10 c.f. DUAL WHEEL	per w.b.	1 w.b.
C6	Jackson Promotional Wheelbarrow 6 c.f.	per w.b.	1 w.b.
C6P	Jackson Promotional POLY Wheelbarrow 6 c.f.	per w.b.	1 w.b.
C6STFF	Jackson Wheelbarrow 6 c.f. / Steel Handle-Flat Free	per w.b.	1 w.b.

Wheelbarrow Parts

Order Code	Product Description	Packaged	Min Order
MPB	Jackson "M" Parts Bag (Hardware Only)	per bag	1 bag
JMH	Jackson "M" Wooden Handles (Pair)	per pair	1 pair
JPB	Jackson "M" Parts Box (Everything but Tray/Handles)	per box	1 box
FFTCC	Jackson 8" FLAT FREE Wheel Only	per wheel	1 wheel
T22	Jackson 8" Wheel Only	per wheel	1 wheel



Jackson® wheelbarrows are the professionals' choice for superior quality, value and performance.

Heavy duty steel trays, professional grade steel undercarriages and strong hardwood handles add up to the toughest, most dependable wheelbarrows on the jobsite. Don't compromise, choose Jackson and get the job done.

Mixing Boxes

Order Code	Product Description	Packaged	Min Order
MBP	Jackson POLY Mixing Box 9 c.f.	per box	1 box
MB6	Vestal #6 Mortar Box 6 c.f.	per box	1 box
MB9	Vestal #9 Mortar Box 9 c.f.	per box	1 box
MB15	Vestal #15 Mortar Box 15 c.f.	per box	1 box
MB18	Vestal #18 Mortar Box 18 c.f.	per box	1 box

Poly Mixing Box



Mixing Pans & Stands

Order Code	Product Description	Packaged	Min Order
1MP	Jackson #1 Mortar Pan 3 c.f.	per pan	1 pan
1MPP	Gatorback POLY Mortar Pan 3 c.f.	per pan	1 pan
18MPS	Jackson Mortar Pan Stand	per stand	1 stand

Steel Mortar Pan & Stand



Gatorback Poly Mortar Pans

Unlike wood mortarboards that take moisture from mortar and steel pans that are heavy, dent and conduct heat, Gatorback pans eliminate time wasted on retempering mortar. Gatorback pans will hold over 175 pounds (1.5 cu.ft.) of mortar to keep masonry crews working and only weigh 8 pounds. At .33 inches thick, the bottom of the Gatorback mortarpan is 100% thicker than other mortarpan. Since this area of the pan is the backbone of the tool and will take the majority of daily abuse, our engineers reinforced the area to exceed the contractor's expectations.

Shovels

Order Code	Product Description	Packaged	Min Order
BMTDR	UNION Short D-Handle Round Point Shovel	per shovel	1 shovel
BMTDS	UNION Short D-Handle Square Point Shovel	per shovel	1 shovel
BMTLR	UNION Long Handle Round Point Shovel	per shovel	1 shovel
BMTLS	UNION Long Handle Square Point Shovel	per shovel	1 shovel
RZRDHRP	RAZORBACK "D"Hdl Rnd Point Shovel	per shovel	1 shovel
RZRDHSP	RAZORBACK "D"Hdl Sq.Point Shovel	per shovel	1 shovel
RZRLHRP	RAZORBACK Long Hdl Rnd Point Shovel	per shovel	1 shovel
RZRLHSP	RAZORBACK Long Hdl.Sq.Point Shovel	per shovel	1 shovel

Rakes

Order Code	Product Description	Packaged	Min Order
BMB16	BLUE MAX Bow Rake 16-Tine	per rake	1 rake
BM16L	BLUE MAX Level Head Rake 16-Tine	per rake	1 rake
B14	JACKSON Bow Rake 14-Tine	per rake	1 rake
1014L	PONY Asphalt Rake 15.5"Head	per rake	1 rake
X14	AMES Stone Rake 15.5" Head	per rake	1 rake
BDCRH	JACKSON Concrete Rake w/Hook 18"	per rake	1 rake

Tampers

Order Code	Product Description	Packaged	Min Order
TAMP	AMES Tamper 8" x 8" Wood Handle	per tamper	1 tamper
TAMP10	AMES Tamper 10"x 10" Wood Handle	per tamper	1 tamper

Hoes

Order Code	Product Description	Packaged	Min Order
PG7P	AMES Mortar Hoe 7"x 4-1/4"	per hoe	1 hoe
BDM29	AMES Mortar Hoe 9"x 6"	per hoe	1 hoe
RZRREMH	RAZORBACK Mortar Hoe Round Edged	per hoe	1 hoe

Axe / Sledge & Demo Hammers / Post Hole Digger / Lute

Order Code	Product Description	Packaged	Min Order
AXE	AMES Dayton Axe 4lb #1190600	per axe	1 axe
LUTE	AMES Contractor Lute 36"	per lute	1 lute
TPHD	AMES Post Hole Digger	per digger	1 digger
DFS8	AMES Double Faced Sledge 8lb - Hickory Handle	per hammer	1 hammer
PULVER	AMES Pulverizer Concrete Demo Hammer	per hammer	1 hammer

Section 6: Pipe and Fittings / Drainage Products

Corrugated Pipe

Order Code	Product Description	Packaged	Min Order
CP3100P	Corrugated Pipe 3"x 100' Perf	per roll	1 roll
CP3100S	Corrugated Pipe 3"x 100' Solid	per roll	1 roll
CP3250P	Corrugated Pipe 3"x 250' Perf	per roll	1 roll
CP3250S	Corrugated Pipe 3"x 250' Solid	per roll	1 roll
CP4100FW	Corrugated Pipe 4"x 100' Perf w/ Filter Wrap	per roll	1 roll
CP4100P	Corrugated Pipe 4"x 100' Perf	per roll	1 roll
CP4100S	Corrugated Pipe 4"x 100' Solid	per roll	1 roll
CP410PC	Corrugated Pipe 4"x 10' Perf	10/bundle	1 bundle
CP410SC	Corrugated Pipe 4"x 10' Solid	10/bundle	1 bundle
CP4250FW	Corrugated Pipe 4"x 250' Perf w/ Filter Wrap	per roll	1 roll
CP4250P	Corrugated Pipe 4"x 250' Perf	per roll	1 roll
CP4250S	Corrugated Pipe 4"x 250' Solid	per roll	1 roll
CP6100P	Corrugated Pipe 6"x 100' Perf	per roll	1 roll
CP6100S	Corrugated Pipe 6"x 100' Solid	per roll	1 roll



Corrugated Pipe Rolls (Perf or Solid)



Corrugated Pipe w/ Filter Fabric

Fittings for Corrugated Pipe

Order Code	Product Description	Packaged	Min Order
C-104	Corrugated 4" Snap Coupler	20/Box	1 box
C-1043	Corrugated 4"x 3" Reducer	20/Box	1 box
C-106	Corrugated 6" Snap Coupler	8/Box	1 box
C-1064	Corrugated 6"x 4" Reducer	8/Box	1 box
C-1403	Corrugated 3" External End Cap	20/Box	1 box
C-1404	Corrugated 4" External End Cap	30/Box	1 box
C-1406	Corrugated 6" External End Cap	10/Box	1 box
C-1703	Corrugated Downspout Adapter 2x3x3	15/Box	1 box
C-1704	Corrugated Downspout Adapter 2x3x4	18/Box	1 box
C-1705	Corrugated Downspout Adapter 3x4x4	15/Box	1 box
C-203	Corrugated 3" Internal Coupler	30/Box	1 box
C-204	Corrugated 4" Internal Coupling	25/Box	1 box
C-303	Corrugated 3" 90o Elbow	15/Box	1 box
C-304	Corrugated 4" 90o Elbow	12/Box	1 box
C-306	Corrugated 6" 90o Elbow	4/Box	1 box
C-803	Corrugated 3" Tee	12/Box	1 box
C-804	Corrugated 4" Tee	12/Box	1 box
C-806	Corrugated 6" Tee	4/Box	1 box
C-816	Corrugated 6" Blind Tee/Elbow	3/Box	1 box
C-903	Corrugated 3" Wye	10/Box	1 box
C-904	Corrugated 4" Wye	8/Box	1 box
C-906	Corrugated 6" Wye	4/Box	1 box
MF4	4" S&D to 4" Corrugated Pipe Connector	1/Box	1 box



Sewer and Drain Pipe (ie: Schedule 20 / PVC)

Order Code	Product Description	Packaged	Min Order
SD310P	S & D Pipe 3"x 10' PERF	100/skid coex (or 138/skid triple wall)	1 skid
SD310S	S & D Pipe 3"x 10' Solid	100/skid coex (or 138/skid triple wall)	1 skid
SD410P	S & D Pipe 4"x 10' PERF	90/skid coex & triple wall	1 skid
SD410S	S & D Pipe 4"x 10' Solid	90/skid coex & triple wall	1 skid
SD610P	S & D Pipe 6"x 10' PERF	39/skid coex only (no triple wall)	1 skid
SD610S	S & D Pipe 6"x 10' Solid	39/skid coex only (no triple wall)	1 skid



Sewer & Drain Pipe (Schedule 20 / PVC)



Note: Triple Wall PVC has a different bell end than Coex PVC (see below), but fittings work on both styles.

Fittings for Sewer and Drain Pipe (ie: Schedule 20 / PVC)

Order Code	Product Description	Packaged	Min Order
V103	S & D 3" Coupling HxH	50/box	1 box
V104	S & D 4" Coupling HxH	50/box	1 box
V1043	S & D 4"x 3" Coupling HxH	40/box	1 box
V106	S & D 6" Coupling 6" HxH	24/box	1 box
V1064	S & D 6"x 4" Coupling HxH	24/box	1 box
V1104	S & D 4" Sanitary Tee's HxHxH	25/box	1 box
V1403	S & D 3" Cap H	30/box	1 box
V1404	S & D 4" Cap H	30/box	1 box
V1406	S & D 6" Cap H	30/box	1 box
V1703	S & D Downspout Adapter 2x3x3	50/box	1 box
V1704	S & D Downspout Adapter 2x3x4	50/box	1 box
V1705	S & D Downspout Adapter 3x4x4	25/box	1 box
V1706	S & D Downspout Adapter 4x6x6	15/box	1 box
V1714	S & D Offset Downspout Adapter 2x3x4	25/box	1 box
V1715	S & D Offset Downspout Adapter 3x4x4	25/box	1 box
V1803	S & D 3" Drain Grate	50/box	1 box
V1804	S & D 4" Drain Grate	40/box	1 box

V1806	S & D 6" Drain Grate	30/box	1 box
V1903	S & D 3" Threaded Clean-Out (female)	40/box	1 box
V1904	S & D 4" Threaded Clean-Out (female)	20/box	1 box
V1906	S & D 6" Cleanout S x FIP	12/box	1 box
V2003	S & D 3" Threaded Plug (male)	50/box	1 box
V2004	S & D 4" Threaded Plug (male)	50/box	1 box
V2006	S & D 6" Threaded Plug (male)	12/box	1 box
V2043	S & D 4" to 3" HxH Coupling	40/box	1 box
V2044	S & D 4" x 4" SWR x DWV Coupling	25/box	1 box
V303	S & D 3" 90o 1/4 Bend HxH	25/box	1 box
V304	S & D 4" 90o 1/4 Bend HxH	36/box	1 box
V306	S & D 6" 90o 1/4 Bend HxH	12/box	1 box
V3304	S & D 4" 90 Deg. Short Bend HxH	25/box	1 box
V403	S & D 3" 90o 1/4 Bend HxS	25/box	1 box
V404	S & D 4" 90o 1/4 Bend HxS	36/box	1 box
V406	S & D 6" 90o 1/4 Bend HxS	12/box	1 box
V503	S & D 3" 45o 1/8 Bend HxH	30/box	1 box
V504	S & D 4" 45o 1/8 Bend HxH	60/box	1 box
V506	S & D 6" 45o 1/8 Bend HxH	18/box	1 box
V603	S & D 3" 45o 1/8 Bend HxSPG	30/box	1 box
V604	S & D 4" 45o 1/8 Bend HxSPG	60/box	1 box
V606	S & D 6" 45o 1/8 Bend HxSPG	18/box	1 box
V703	S & D 3" 22.5o 1/16 Bend HxH	25/box	1 box
V704	S & D 4" 22.5o 1/16 Bend HxH	30/box	1 box
V706	S & D 6" 22.5o 1/16 Bend HxH	20/box	1 box
V803	S & D 3" Tee's HxHxH	30/box	1 box
V804	S & D 4" Tee's HxHxH	30/box	1 box
V806	S & D 6" Tee's HxHxH	8/box	1 box
V8064	S & D 6" x 4" Tee's HxHxH	8/box	1 box
V903	S & D 3" 45o Wye's HxHxH	25/box	1 box
V904	S & D 4" 45o Wye's HxHxH	24/box	1 box
V906	S & D 6" 45o Wye's HxHxH	6/box	1 box
V9064	S & D 6" x 4" 45o Wye's HxHxH	8/box	1 box
VPUP4	POP-UP Emitter w/ 4" Ell	8/box	1 box



**Fittings for Sewer & Drain (ie: Schedule 20 / PVC) to Cast Iron Pipe Converters
"FERNCO Style Fittings"**

Order Code	Product Description	Packaged	Min Order
IS156-43	Indiana Seal 4" x 3" CI/PVC Coupler	per coupler	1 coupler
IS156-44	Indiana Seal 4" x 4" CI/PVC Coupler	per coupler	1 coupler
IS156-64	Indiana Seal 6" x 4" CI/PVC Coupler	per coupler	1 coupler
IS156-66	Indiana Seal 6" x 6" CI/PVC Coupler	per coupler	1 coupler



Indiana Seal offers a complete line of couplings for clay, cast iron, ductile iron, concrete and plastic pipe - and with sizes ranging from 1 1/4 - 27 inches, we've got the perfect fit for any job. Constructed of tough, yet pliable PVC, our couplings hold strong against hazards like sewer gases, chemicals, fungus growth, various soil conditions, roots and other in-ground dangers that can lead to leaks and breakdowns in your system. Every coupling is produced and inspected under strict quality control standards to guarantee the highest degree of integrity at any junction in the line.

Cement / Primer for Sewer & Drain (ie: Schedule 20 / PVC) Pipe

Order Code	Product Description	Packaged	Min Order
PVCCEMP	PVC Cement Pint	12/case	1 case
PVCCEMQ	PVC Cement Quart	12/case	1 case
PVCPRIMER	PVC Primer Pint	12/case	1 case

Solvent Weld and Gasket SDR 35 Green Pipe

Order Code	Product Description	Packaged	Min Order
SDR410P	SDR 35 Solvent Weld 4"x 10' PERF	90/skid	1 skid
SDR410S	SDR 35 Solvent Weld 4"x 10' Solid	90/skid	1 skid
SDR4S	SDR 35 Gasket Pipe 4"x 14' Solid	90/skid	1 skid
SDR610P	SDR 35 Solvent Weld 6"x 10' PERF	90/skid	1 skid
SDR610S	SDR 35 Solvent Weld 6"x 10' Solid	35/skid	1 skid
SDR6S	SDR 35 Gasket Pipe 6"x 14' Solid	35/skid	1 skid



Fittings for SDR 35 Green Pipe

Solvent Weld Fittings: Use the S&D (PVC/Sch 20) fittings on previous page

Gasket Fittings: We do not stock, see plumbing distributor for availability

SDR 35 Green Pipe for Solvent Weld and Gasket

Schedule 40 Pipe

Order Code	Product Description	Packaged	Min Order
S410P	SCH.40 Pipe 4"x 10' PERF Bell End	48/skid	1 skid
S410S	SCH.40 Pipe 4"x 10' Solid BELL End	48/skid	1 skid
S610S	SCH.40 Pipe 6"x 10' Solid BELL End	20/skid	1 skid

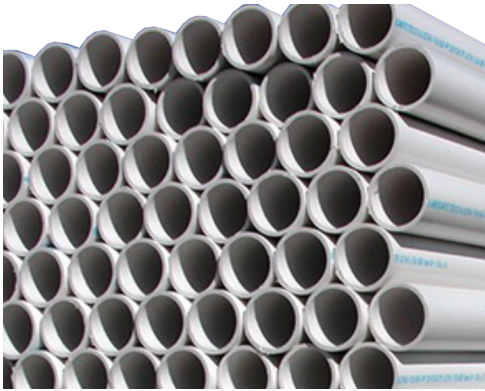

Schedule 40 Pipe

Schedule 40 Fittings

Order Code	Product Description	Packaged	Min Order
S422	SCH. 40 22o Elbow 4" HxH	10/box	1 box
S43R	SCH. 40 Reducer 4"to 3" HxH	20/box	1 box
S445	SCH. 40 45o Elbow 4" HxH	10/box	1 box
S490	SCH. 40 90o Elbow 4" HxH	10/box	1 box
S4C	SCH. 40 Coupling 4" HxH	10/box	1 box
S4CP	SCH. 40 PVC Cap 4"	10/box	1 box
S4FA	SCH. 40 Female Adapter (Clean-out) 4"	10/box	1 box
S4P	SCH. 40 Threaded Plug 4"	10/box	1 box
S4T	SCH. 40 Sanitary Tee 4" HxHxH	10/box	1 box
S4Y	SCH. 40 Wye 4" HxHxH	5/box	1 box
S622	SCH. 40 22o Elbow 6" HxH	5/box	1 box
S645	SCH. 40 45o Elbow 6" HxH	1/box	1 box
S64R	SCH. 40 Reducer 6"to 4" HxH	4/box	1 box
S690	SCH. 40 90o Elbow 6" HxH	1/box	1 box
S6C	SCH. 40 Coupling 6" HxH	1/box	1 box
S6CP	SCH. 40 PVC Cap 6"	10/box	1 box
S6FA	SCH. 40 Female Adapter (Clean-out) 6"	10/box	1 box
S6P	SCH. 40 Threaded Plug 6"	10/box	1 box
S6T	SCH. 40 Sanitary Tee 6" HxHxH	1/box	1 box
S6Y	SCH. 40 Wye 6" HxHxH	1/box	1 box



Section 7: Drainage Products

Sump Pits and Sump Wells

Order Code	Product Description	Packaged	Min Order
CP1524SPG	Sump Pit GALV. 15"x 24" *PERF & OPEN BOTTOM*	per pit	1 pit
CP1524SPP	Sump Pit PLASTIC 15"x 24" *PERF & OPEN BOTTOM*	per pit	1 pit
AASHTO15	20' x 15" Sump Pit PLASTIC PIPE *PERF*	per pipe	1 pipe
CP1524ADL	ADS 1524ADL - Plastic 2-Pump Sump Well 18"x 24" PENN	per well	1 well
CP1537AD	ADS 1537AD - Plastic 2-Pump Sump Well HD Lid PENN	per lid	1 lid
CP1824SPW	ADS 1524ADH - Plastic Sump Well 18"x 24"	per well	1 well
CPLIDS	ADS 1537ADL - Plastic Sump Well Lid	per lid	1 lid
CPRADONLID	ADS 1538AD - RADON Plastic Sump Well Lid	per lid	1 lid



15"x24"
Open Bottom Sump Pit
Our Code: CP1524SPP



18"x24"
ADS 1524ADL "PENN" Sump Well
Our Code: CP1524ADL



18"x24"
ADS 1524ADH Sump Well
Our Code: CP1824SPW

Bell Traps (Cast Iron or Plastic)

Order Code	Product Description	Packaged	Min Order
BT12	Bell Trap Cast Iron Lid Only for 12"x 12"	per lid	1 lid
BT1212	Bell Trap Cast Iron 12"x 12"x 4" w/lid	per trap	1 trap
BT6	Bell Trap Cast Iron Lid Only 6"x 6"	per lid	1 lid
BT66	Bell Trap Cast Iron 6"x 6"x 2"w/lid	per trap	1 trap
BT66P	Bell Trap Plastic 6" x 6"	per trap	1 trap
BT9	Bell Trap Cast Iron Lid Only 9"x 9"	per lid	1 lid
BT99	Bell Trap Cast Iron 9"x 9"x 3"w/lid	per trap	1 trap
BT99P	Bell Trap Plastic 9"x 9"	per trap	1 trap



Cast Iron Bell Trap



Plastic Bell Trap

Cast Iron Square Flat Grates

Order Code	Product Description	Packaged	Min Order
SP66	Vestal Square Flat Grate Cast Iron 6"x 6"	per grate	1 grate
SP88	Vestal Square Flat Grate Cast Iron 8"x 8"	per grate	1 grate
SP10	Vestal Square Flat Grate Cast Iron 10"x 10"	per grate	1 grate
SP12	Vestal Square Flat Grate Cast Iron 12"x 12"	per grate	1 grate

Cast Iron Trench Grates

Order Code	Product Description	Packaged	Min Order
HTD6	Vestal Trench Grate Cast Iron 6"x18"x3/4"	per grate	1 grate
HTD8	Vestal Trench Grate Cast Iron 8"x 24"x 1"	per grate	1 grate
HTD12	Vestal Trench Grate Cast Iron 12"x24"x1"	per grate	1 grate
HTD18	Vestal Trench Grate Cast Iron 8"x18"x3/4"	per grate	1 grate

Cast Iron Manhole Covers and Frames

Order Code	Product Description	Packaged	Min Order
SQ11	Vestal Square Frame & Grate Set, Cast Iron 12"x 12"	per set	1 grate
SQ13	Vestal Square Frame & Grate Set, Cast Iron 18"x 18"	per set	1 grate
SQ15	Vestal Square Frame & Grate Set, Cast Iron 24"x 24"	per set	1 grate
****	Can order frames & grates as separate pieces	per piece	1 piece

Cast Iron Round Manhole Cover and Frames

Order Code	Product Description	Packaged	Min Order
R18F	Vestal Round Heavy Cast Iron Frame 18"	per frame	1 frame
R18G	Vestal Round Cast Iron Grated 18"	per grate	1 grate
R18S	Vestal Round Cast Iron Cover SOLID 18"	per cover	1 cover

Tuf-Tite Linear Drainage Systems (Residential & Commercial)

Order Code	Product Description	Packaged	Min Order
TR1	Tuf-Tite 36" Trench Drain W/Grate	per drain	1 drain
TR1-GCF	Tuf-Tite Female Gender Change	per part	1 part
TR1-GCM	Tuf-Tite Male Gender Change	per part	1 part
TR190	Tuf Tite 90 Degree Corner W/Grate	per corner	1 corner
TR1D4	Tuf-Tite 4" End Drain for TR1	per drain	1 drain
AD1	Tuf-Tite Area Drain 11"x 11" AD1	per drain	1 drain
BI-DG	Tuf-Tite GRATE ONLY 11"x 11" GREEN	per grate	1 grate
B1-DG	Tuf-Tite GRATE Only 11"x 11" Black	per grate	1 grate
B4-DG	Tuf-Tite GRATE Only 16"x 16" Black	per grate	1 grate
B1-RIS	Tuf-Tite 11"x 11" Drain Riser	per riser	1 riser
B4-RIS	Tuf-Tite 16"x 16" Drain Riser	per riser	1 riser
TPAN12	Tuf-Tite 6"x 12" Trench Pan	per pan	1 riser
TPAN36	Tuf-Tite 36" Trench Pan	per pan	1 pan
RIS-24	Tuf-Tite Septic Tank Riser 24"x 6"	per riser	1 riser
RIS-24X12	Tuf-Tite Septic Tank Riser 24"x 12"	per riser	1 riser
RISL-24	Tuf-Tite 24" Domed Septic Riser Lid	per riser	1 riser
TT	Tuf-Tite Drain Sump 11"x 11"x 15"H	per sump	1 sump
TT2	Tuf-Tite Drain Sump 9"x 14"x 9"H	per sump	1 sump
TT3	Tuf-Tite Drain Sump 16"x 16"x 15"H	per sump	1 sump



Tuf-Tite TR1 Trench Drains and Accessories

The TR1 is a 36" drain for linear hardscape surfaces. It comes completely assembled, ready to install with 2 snap-on end caps.

The TR1's molded in ribs help give it a H-20 load rated (235 psi) for heavy traffic wheel load rating (Load Class C), so it can be used on warehouse factory floors and will hold up to fully loaded forklift traffic and loading docks. The TR1 also fully complies with ADA.

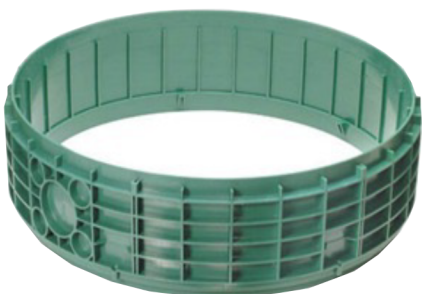

Tuf-Tite Risers, Trench Pans, and Sumps

With multiple sizes and load ratings, these products are handy for those looking for value and compatibility. All of these units come with various seals to attach S-85 Universal, S-35 for 4" SDR35, or S-40 for 4" Sch40.

E-Z Drains & Red-E-Form Linear Drain System (Residential & Commercial)

Order Code	Product Description	Packaged	Min Order
EP06	E-Z DRAIN 6" Solid End Plate	per piece	1 piece
EP06H4	E-Z DRAIN 6" End Plate W/ 4.5"Hole	per piece	1 piece
TD0648T1	E-Z DRAIN 6"x 48" W/ Std. Steel Grate	per piece	1 piece
TD0660T1	E-Z DRAIN 6"x 60" W/ Std. Steel Grate	per piece	1 piece
TD0672T1	E-Z DRAIN 6"x 72" W/ Std. Steel Grate	per piece	1 piece
EP12	Red-E-Form 12" Solid End Plate	per piece	1 piece
EP12H4	Red-E-Form 12" End Plate W/ 4.5" Hole	per piece	1 piece
TD1248T1	Red-E-Form 12"x48" W/ Std. Steel Grate	per piece	1 piece

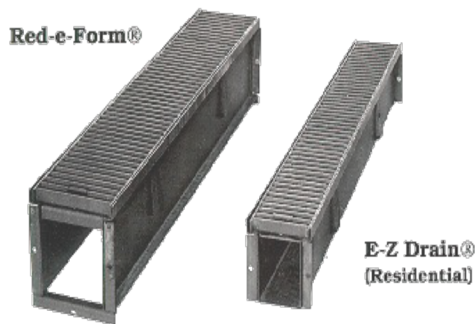

Red-E-Forms

From gas stations and parking lots to factories and garage floor drains, Red-E-Form trench drains are designed for virtually any heavy duty application where durability and performance are a must. Manufactured as complete units, Red-E-Form trench drains offer unusually easy installation and dependable, trouble-free operation.

Easy installation: Completed Red-E-Form trench drain units bolt together so that the entire system can be connected before being positioned in the drain trench. This ensures fast, easy installation, provides more rigid support and allows greater control in placement.

No multiple sloping: Unlike many other trench drains, the Red-E-Form system does not require multiple surface sloping. Since the drains are bottomless to allow on-site grading, you have unlimited grade/distance potential. Therefore, you can run a single drain the entire length of the trench drain area and eliminate the need for multi-sloping.

Single pour installation, no footers or forms: Because the drains are produced with an open bottom, the need for sloped footers and forms is eliminated. All you need to do is position the assembled system in the trench, and pour and grade as you go. You make the footer, form and grade with one pour. And that saves you time, money and materials.

Anchor clips: an added benefit: Anchor clips keep the components in position during installation and prevent the system from heaving - even under the most extreme conditions - when the job is complete.

E-Z Drains

Same benefits as the Red-E-Form, but smaller size for residential uses, the E-Z-Drain systems offer the same easy installation, effective maintenance free performance and rugged construction of Red-E-Form systems, but have been specifically designed for residential use. E-Z-Drain systems are available only in 6" widths and are constructed with a roll-formed bottom plate. E-Z-Drains are designed for handling smaller surface areas, such as driveways and garages.

Drain Rite Drainage System (Pool and Decks)

Order Code	Product Description	Packaged	Min Order
MDR	Mortex Drain Rite White 10'	10/box	1 box
MDRC	Mortex Drain Rite SELECT COLOR 10'	10/box	1 box
DX45W	Mortex Drain Rite Fitting 45 Degree	per piece	1 piece
DX90W	Mortex Drain Rite Fitting 90 Degree Angle	per piece	1 piece
DXC	Mortex Drain Rite Fitting Coupler	per piece	1 piece
DXCOCW	Mortex Drain Rite Fitting Clean Out Cover	per piece	1 piece
DXDS	Mortex Drain Rite Fitting Down Spout	per piece	1 piece
DXECW	Mortex Drain Rite Fitting End Cap	per piece	1 piece
DXESW	Mortex Drain Rite Fitting End Spout	per piece	1 piece
DXNC	Mortex Drain Rite Fitting Nailing Clip	per piece	1 piece
DXSSW	Mortex Drain Rite Fitting Straight Spout	per piece	1 piece
DXTW	Mortex Drain Rite Fitting Tee	per piece	1 piece
DXXW	Mortex Drain Rite Fitting Cross	per piece	1 piece

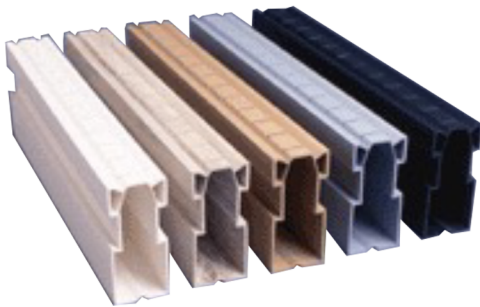

Mortex Drain Rite

Drain Rite® is a lineal, heavy-wall one piece contractual joint system for concrete crack control and water drainage. Drain Rite features obstruction free water flow, because it uses outside couplers. Drain Rite is available in five colors, including the only marble colored PVC drain in the industry. All extrusion and compounding is done in-house to assure the highest quality.

- Designed to set flush against walls and porches
- Non-directional system requiring a minimum of fittings
- Locked into the concrete by inside key ways that stop the flow of water to the subsoil
- Used as a screed guide for concrete finisher

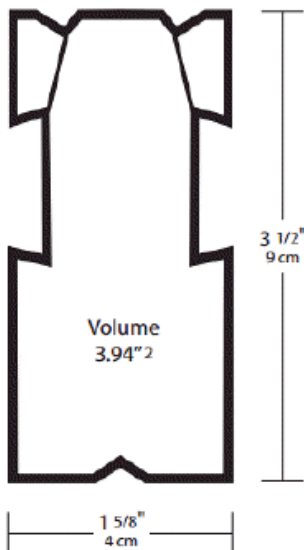

Pave Rite Drainage System (Interlocking Paver Drains)

Order Code	Product Description	Packaged	Min Order
MPRG	Mortex Pave Rite- Grey 10' 8/Box	8/box	1 box
MPRT	Mortex Pave Rite -Tan 10' 8/Box	8/box	1 box
MPRW	Mortex Pave Rite- White 10' 8/box	8/box	1 box
PRX45G	Mortex Pave Rite 45 Degree Angle-Grey	per piece	1 piece
PRX45T	Mortex Pave Rite 45 Degree Angle -Tan	per piece	1 piece
PRX90G	Mortex Pave Rite 90 Degree Angle-Grey	per piece	1 piece
PRX90T	Mortex Pave Rite 90 Degree Angle-Tan	per piece	1 piece
PRXECG	Mortex Pave Rite End Cap-Grey	per piece	1 piece
PRXECT	Mortex Pave Rite End Cap-Tan	per piece	1 piece
PRXESG	Mortex Pave Rite End Spout-Grey	per piece	1 piece
PRXEST	Mortex Pave Rite End Spout-Tan	per piece	1 piece
PRXSSG	Mortex Pave Rite Straight Spout-Grey	per piece	1 piece
PRXSST	Mortex Pave Rite Straight Spout-Tan	per piece	1 piece



Mortex Pave Rite

Pave Rite is specially designed for superior drainage within paver decking. It is a two piece, linear, water channel draining system. Due to its design and heavy walled construction, warping and bowing found in other drain systems are greatly reduced. Pave Rite's full two inch top provides greater water flow from the deck surface, and it has the stylish look that is perfect for upscale paver installations. All extrusion and compounding is done in-house to assure the highest quality.

- Designed to set flush against walls and porches
- Non-directional system requiring a minimum of fittings
- Locked into the pavers by outside tab.

Weep Holes / Screenshot / Cell Vent

Order Code	Product Description	Packaged	Min Order
WEEP	Weep Holes (Clear, Plastic)	1000/box	1 box
WEEPS78	Weep Screenshot 10' GALV. 7/8"	10/bundle	1 bundle
BMCVG	Cell Vent 3/8"x 2-1/2"x 3-3/8" (Gray)	per vent	1 vent

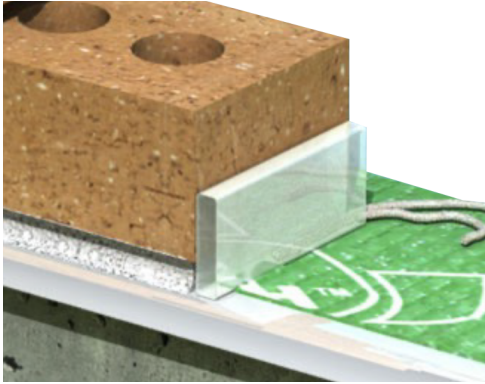

Weep Hole

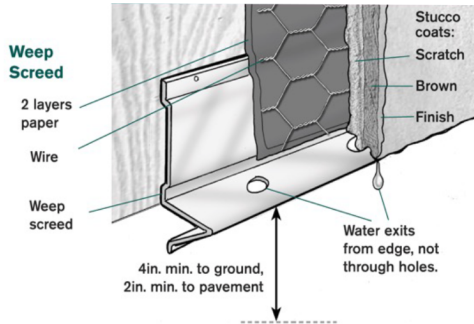

Weep Screenshot

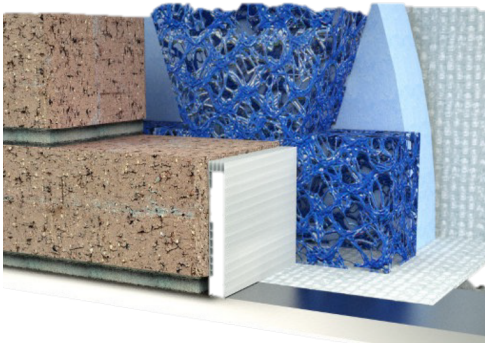

Cell Vent

Section 8: Hardscape and Geotextiles

ADA Tactile Mats / Parking Curbs / Speed Bumps

Order Code	Product Description	Packaged	Min Order
TT2448-SA-BRD	Tuf-Tite ADA Surface Applied Tactile Tile Red	per tile	1 tile
TT2448-SA-GRY	Tuf-Tite ADA Surface Applied Tactile Tile Grey	per tile	1 tile
TT2460-SA-GRY	ADA SURFACE Applied Tactile Tile GREY (2' x 5')	per tile	1 tile
TT2460-SA-SRD	ADA SURFACE Applied Tactile Tile SAFETY Red (2' x 5')	Per tile	1 tile
TT2448-WS-BRD	Tuf-Tite ADA Wet Set Tactile Tiles Red	per tile	1 tile
TT2448-WS-GRY	Tuf-Tite ADA Wet Set Tactile Tiles Grey	per tile	1 tile
TT2460-WS-GRY	ADA WET Set Tactile Tiles GREY (2' x 5')	per tile	1 tile
TT2460-WS-SRD	ADA WET Set Tactile Tiles SAFETY RED (2' x 5')	per tile	1 tile

10 tiles per box

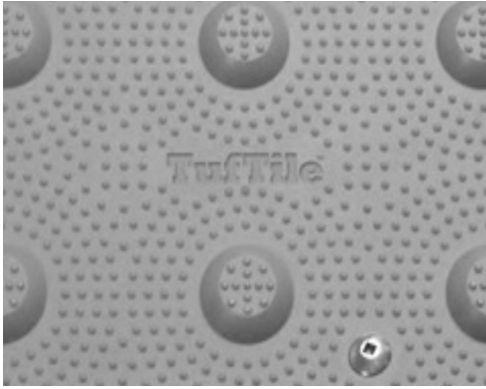

Tuf-Tite ADA Surface & Wet-Set Tactile Tiles

Tuftile's Polymer Wet-Set (cast-in-place) or Surface Applied Tiles are replaceable high-impact detectable warning tiles designed for years of use on municipal (public) and private sidewalks, pedestrian ramps and platforms. Tuftile Polymer Tiles are made of advanced proprietary polymers and are engineered with molded in-line truncated domes which are in full compliance with ADA guidelines and provide superior impact and slip resistance. Tuftiles are also highly resistant to UV rays, weather, and a wide variety of chemicals.

- **Polymer Wet-Set** tiles utilize a factory installed umbrella style anchor system with stainless steel, tamper resistant fasteners for easy installation into wet concrete applications.
- **Polymer Surface Applied** anchors hold tight to stainless steel, tamper resistant fasteners and are easily installed into existing concrete or retrofitting installations. Alternatively, drive pins can be used in most installations.

Landscape Fabric

Order Code	Product Description	Packaged	Min Order
LF1300	1'x 300' Landscape Fabric	per roll	1 roll
LF2300	2'x 300' Landscape Fabric	per roll	1 roll
LF3100	3'x 100' Landscape Fabric	12 rolls/box	1 box
LF3300	3'x 300' Landscape Fabric	per roll	per roll
LF350	3'x 50' Landscape Fabric	27 rolls/box	1 box
LF4100	4'x 100' Landscape Fabric	12 rolls/box	1 box
LF4300	4'x 300' Landscape Fabric	per roll	1 roll
LF6100	6'x 100' Landscape Fabric	per roll	1 roll
LF6300	6'x 300' Landscape Fabric	per roll	1 roll
LF9300	9'x 300' Landscape Fabric	per roll	1 roll
LF12300	12'x 300' Landscape Fabric	per roll	1 roll
LF15300	15'x 300' Landscape Fabric	per roll	1 roll



Hanes Geo Components Non-Woven Pro Silver Plus Landscape Fabric

Constructed of polyester fibers which provide exceptional UV stability and outstanding water and air permeability, Pro Silver Plus™ serves as excellent weed barrier and filter fabric while the strength characteristics make this fabric a superior in underlayment applications. 3-ounce per yard weight. 20 year warranty! Applications: Behind Retaining Walls, Around Pipes, Under Patios, Sidewalks, Flower Beds and Mulched Areas.

Geo Grid, Filter, & Stabilization Fabrics

Order Code	Product Description	Packaged	Min Order
B100	TerraGrid 20 Geo Grid 4'x 50'	per roll	1 roll
G35	TerraGrid 35 Geo Grid 12'x 150'	per roll	1 roll
G55	TerraGrid 55 Geo Grid 12'x 150'	per roll	1 roll
FF360	TerraTex NO4 3'x 360' Filter Fabric	per roll	1 roll
LF15NO4	TerraTex NO4 15'x 360' Filter Fabric	per roll	1 roll
LF12NO4	TerraTex NO4 12.5'x 360' Filter Fabric	per roll	1 roll
LF6NO4	TerraTex NO4 6.25'x 360' Filter Fabric	per roll	1 roll
SF6	TerraTex GS 6'3"x 432' Stabilization Fabric	per roll	1 roll
SF6*	TerraTex GS 6'3"x 108' Stabilization Fabric	per roll	1 roll
SF12*	TerraTex GS 12.5'x 108' Stabilization Fabric	per roll	1 roll
SF12.5	TerraTex GS 12.5'x 432' Stabilization Fabric	per roll	1 roll
SF15	TerraTex GS 15'x 360' Stabilization Fabric	per roll	1 roll



TerraGrid® 20-35-55

TerraGrid® geogrids are made up of woven high tenacity polyester and coated with a polyvinyl chloride (PVC) coating. TerraGrid® geogrid is non-biodegradable and resistant to most soil chemicals, acids, and alkalis with a pH range of 3 to 12.

- TerraGrid 20 = 2,025 lbs ultimate strength
- TerraGrid 35 = 3,600 lbs ultimate strength
- TerraGrid 55 = 5,000 lbs ultimate strength



TerraTex N04

TerraTex® N04 is a nonwoven geotextile made up of polypropylene fibers. These fibers are needled to form a stable and durable network such that the fibers retain their relative position. It is non-biodegradable and resistant to most soil chemicals, acids, and alkali with a pH range of 3 to 12. Weight is 3.5oz/yd.



TerraTex GS

TerraTex® GS is a woven geotextile made up of polypropylene yarns. These yarns are woven to form a stable and durable network such that the yarns retain their relative position. TerraTex® GS meets AASHTO M288 Class 3 for separation and stabilization. It is non-biodegradable and resistant to most soil chemicals, acids, and alkali with a pH range of 3 to 12. Weight is 4oz/yd.

Silt / Safety / Snow Fences and Posts

Order Code	Product Description	Packaged	Min Order
SF36	Pre-Assembled Silt Fence, Black 36"x 100'	per roll	1 roll
SF4	Safety Fence Orange 48" x 50'	per roll	1 roll
SNOWN	Snow Fence, 5-Wire, Natural Wood, 48" x 50'	per roll	1 roll
STP6	Steel Fence Post 6' for Safety/Snow Fences	5/bundle	1 bundle
SS6	Sod Staples 6"	1000/box	1 box



Pre-Assembled Silt Fence, Black 36"x 100'

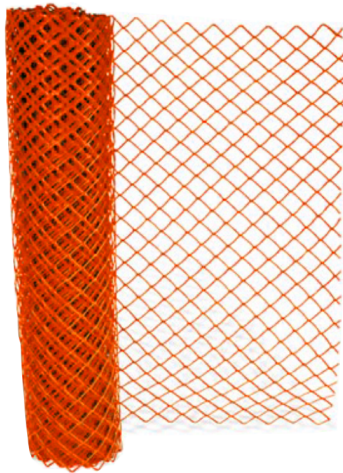

Safety Fence Orange 48" x 50'



Snow Fence, 5-Wire, Natural Wood, 48" x 50'

Polymeric Sand (for Pavers) – 63bags/pallet

Order Code	Product Description	Packaged	Min Order
STA	Evolution BEIGE Polymeric SAND 50#	per bag	1 pallet (63 bags)
STAB	Evolution BLACK Polymeric SAND 50#	per bag	1 pallet (63 bags)
STAG	Evolution GREY Polymeric SAND 50#	per bag	1 pallet (63 bags)
STASDB	Evolution BEIGE Polymeric Stone Dust 50#	per bag	1 pallet (63 bags)
STASDBL	Evolution BLACK Polymeric Stone Dust 50#	per bag	1 pallet (63 bags)
STASDG	Evolution GREY Polymeric Stone Dust 50#	per bag	1 pallet (63 bags)



Sable Marco's Evolution Polymeric Sand

Specially formulated mixture of graded sand and high-performance polymer binding agent designed for all paver and natural stone joints up to 4" (10 cm)! It's superior performance and durability is ideal for the installation of new pavers or natural stone as well as replacing existing joints. It will remain stable and flexible in the most extreme weather conditions and freeze/thaw cycles when properly installed. Ultimate versatility, for all paver and natural stone joints from 1/8" to 4" (3 mm to 10 cm). Horizontal or sloped surfaces, residential or high-traffic commercial applications. Stabilizes pavers, prevents erosion, ant hills & weed growth. Will not stain pavers, safe to use by the pool. Perfect for cobble stone and driveway apron applications. Three natural colors : grey, beige & black, no pigment or dyes.



Sable Marco Evolution Polymeric Stone Dust

Polymeric Stone Dust is a specially formulated mixture of crushed stone and high-performance polymer binding agent designed for wide paver and natural stone joints up to 6" (15 cm)! It's superior performance and durability is ideal for the installation of new wide joint pavers, natural stone as well as replacing existing joints. It will remain stable and flexible in the most extreme weather conditions and freeze/thaw cycles when properly installed. Ultimate versatility, for all wide joint paver, natural stone joints from 1/4" to 6" (6 mm to 15 cm). Horizontal or sloped surfaces, residential or high-traffic commercial applications. Stabilizes wide joint pavers and natural stones, prevents erosion, ant hills & weed growth. Will not stain stones or pavers, safe to use by the pool. Perfect for cobble stone, driveway apron applications. 3 natural colors : grey, beige & black, no pigment, dyes.

Various Construction / Contractor Products

Order Code	Product Description	Packaged	Min Order
CONTR	Contractor Poly Clean-Up Bags (20/roll)	per roll	1 roll
CT3	Caution Tape 300'	32/box	1 box
PPC	Polyethylene Pallet Covers (75/roll)	per roll	1 roll
SBP	Sand Bag Poly 14-1/2"x 26" w/ties	1000/bundle	1 bundle
STRETCH	Stretch Film 18"x1500'x 80Ga.	4/box	1 box
REINP	Reinforced Polyethylene for Scaffolding 20'x 100'	per roll	1 roll

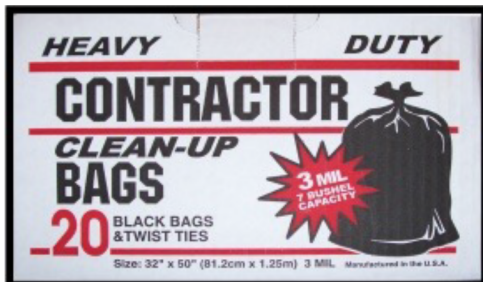

Ice Melts

Order Code	Product Description	Packaged	Min Order
CCP50	Calcium Chloride PELLETS 50 lbs bag	per bag	1 pallet
CCPD	PELADOW Calcium Chloride PELLETS 50 lbs bag	per bag	1 pallet
FCC50	Calcium Chloride FLAKE 50 lbs bag	per bag	1 pallet
FCC100	Calcium Chloride FLAKE 100 lbs bag	per bag	1 pallet
FCCD	DOWFLAKE Xtra Calcium Chloride 50 lbs bag	per bag	1 pallet
MAG50	Magnesium Chloride FLAKE 50 lbs bag	per bag	1 pallet
MAG50P	Magnesium Chloride PELLETS 50 lbs bag	per bag	1 pallet

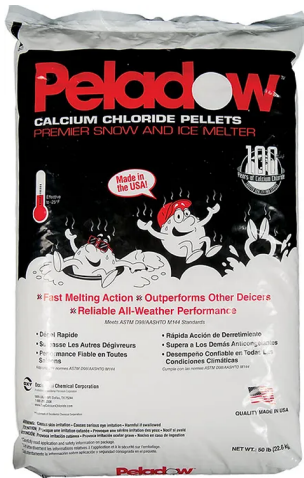

Peladow Premium Calcium Chloride Pellets

When you need to buy professional grade ice melting materials, no ice and snow melt is as effective as Peladow™ calcium chloride pellets. In the snowy cities of Chicago, Cleveland, Boston, and New York, icy sidewalks and parking lots require a high performance deicer that can burn through hard pack snow and ice. Peladow™ brand calcium chloride pellets are the defacto standard of pellet deicers in North America. Calcium chloride pellets, like Peladow™, are highly effective at cold temperatures down to -25F. In fact, Peladow™ calcium chloride pellets are the only deicer that will continue to melt ice dams and hard pack in extremely cold environments. No other ice-melt product works on snow and ice better than Peladow™ Calcium Chloride Pellets.

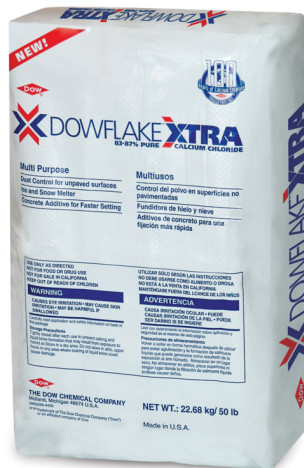

DowFlake Xtra 83-87% Premium Calcium Chloride Flakes

DOWFLAKE™ Xtra 83-87% Calcium Chloride Flakes have 10% more calcium chloride than conventional flake calcium chloride products. They provide more pound-for-pound performance when used for snow and ice control, dust control, road construction and maintenance, concrete acceleration and tire weighting.

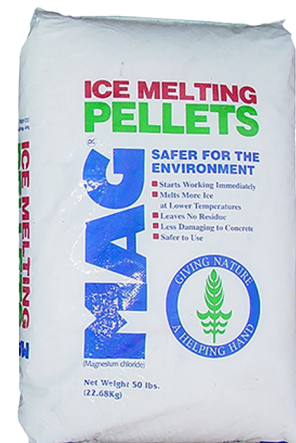

MAG Magnesium Chloride Pellets & Flakes

Naturally harvested from the Dead Sea, MAG® is a premier deicer and premium ice melt product that provides the best performance. It also has the least impact on surrounding areas, which helps to greatly reduce the adverse effects typically associated with chemicals used to combat ice and snow hazards.

Section 9: Veneer Products and Accessories

Diamond Metal Lath (Regular and Self-Furring)

Order Code	Product Description	Packaged	Min Order
GALV25	2.5 Galv.Metal Lath 27"x 96"	10/bundle	1 bundle
GALV34	3.4 Galv.Metal Lath 27"x 96"	10/bundle	1 bundle
GALVSF25	2.5 Galv.Metal Lath *SELF-FURING*	10/bundle	1 bundle
GALVSF34	3.4 Galv.Metal Lath *SELF-FURING*	10/bundle	1 bundle



Diamond Mesh Lath (50 bundles/skid)

Manufactured by slitting and stretching galvanized steel to form small opening to allow the keying of plaster so it will bond to the lath. Each sheet has square ends and smooth parallel edges for fast, easy handling and installation. Diamond Mesh Lath can be bent easily to create curved surfaces.

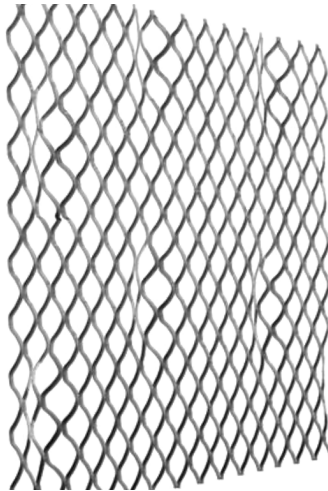

Self-Furred Diamond Mesh Lath (25 bundles/skid)

Codes require metal lath used over solid surfaces to be furred approximately ¼ inch away from the wall to allow for the proper stucco keying behind the lath. Self-furred diamond mesh lath has a surface studded in dimples or embossed “V” groove that provide the required ¼ inch of furring. Fastener placement should be arranged so as not to negate the furring mechanism.

Asphalt Saturated Felt

Order Code	Product Description	Packaged	Min Order
ASF	Asphalt Saturated Felt #15 - ASTM 4869	per roll	1 roll



We stock premium-quality, ASTM rated organic felt that is saturated with asphalt. Accepted for use as an underlayment felt to be applied over the deck prior to the installation of asphalt shingles. 144' x 36" coverage 4 squares / 432 square feet per roll / Laying lines 2", 8-1/2", 11-1/4", 17"

Plaster Reinforcement and Beads

Order Code	Product Description	Packaged	Min Order
X1	X-1 GALV. Expanded Corner Bead 10' lengths	300'/box	1 box
X66	X66 GALV. Casing Bead *1/2"* 10' lengths	300'/box	1 box
X66*	X66 GALV. Casing Bead *3/4"* 10' lengths	300'/box	1 box
EJ15	#15 GALV. Control Joint *1/2"* 10' lengths	240'/box	1 box
EJ15*	#15 GALV. Control Joint *3/4"* 10' lengths	240'/box	1 box

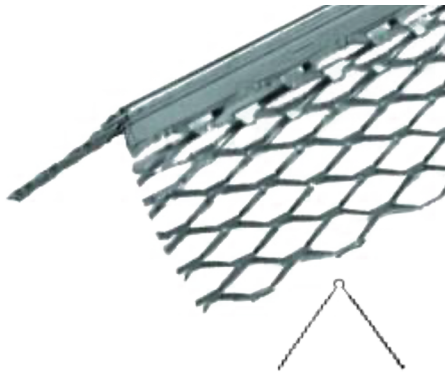

X-1 Expanded Corner Bead

This is the standard accessory for providing exterior corner protection and providing a reliably straight ground for screeding. The 3" expanded mesh wings are easily flexed to adapt to framing irregularities and to match appropriate screed heights.

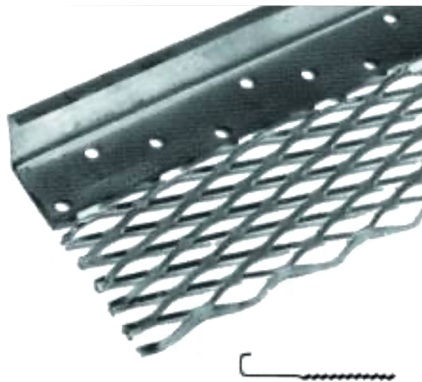

X-66 Casing Bead (i.e.: ends, bottoms, or j-beads)

Casing bead is used as a plaster stop, screed ground, as exposed trim around doors and windows, and as a base screed. The expanded flange width is 3 inches.

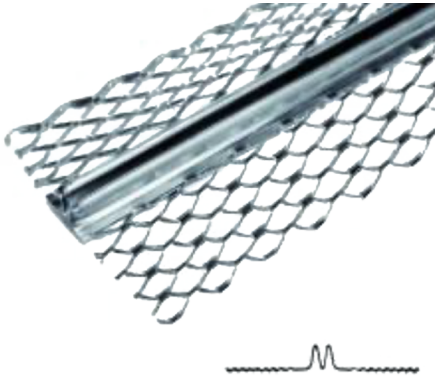

#15 Control Joint

Designed to provide for movement to accommodate expansion and contraction caused by initial stucco

Exterior Wall & Foundation Drainage

Order Code	Product Description	Packaged	Min Order
DWRS	Driwall Exterior Wall Rainscreen 6MM 4' x 65'	per mat	1 mat
DWRS10MM	Driwall Exterior Wall Rainscreen 10MM 4' x 45'	per mat	1 mat
DW025	Driwall Composite Foundation Drain 4'x 100'	per roll	1 roll
DW025/2	Driwall Composite Found. Drain w/Membrane 4'x 75'	per roll	1 roll
DWMD1	Driwall Mortar Deflection 1"x 10" x 50' 4rls/bx	4 rolls/box	1 box
DWMD2	Driwall Mortar Deflection 2"x 10" x 25'	per roll	1 roll
DWPB	Driwall Protection Board 4'x 50'	per roll	1 roll
AMERD	Mel-Drain Soil Sheet Drain 4'x 50' (5035) <u>Fabric</u>	per roll	1 roll
DC450	Draincore Soil Sheet Drain 4'x 50' <u>No Fabric</u>	per roll	1 roll



Driwall Rainscreen

- 020-1 (6MM x 4' x 65')
- 10MM (10MM x 4' x 45')

Driwall™ Rainscreen is a drainage mat for exterior wall systems. The entangled net product eliminates incidental moisture problems in most exterior veneer applications, including stucco, manufactured stone, and plank siding. The 020-1 (.25") is the standard application and code/spec'd in many places throughout the USA. 10MM is recommended for heavier applications like cultured stone.

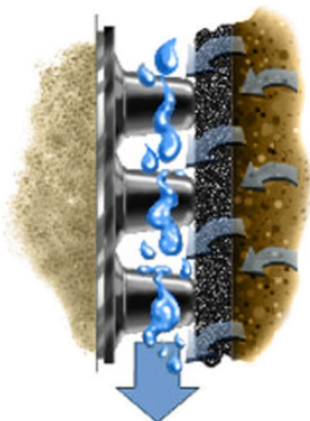

Mel-Drain Soil Sheet Drain - 5035B, 4' x 50' rolls by W.R. Meadows

Mel-Drain is a dimple-raised, molded polystyrene sheet bonded to high strength polypropylene fabric. This geocomposite allows the passage of moisture through the fabric while preventing fine soils from entering the drainage channel. Mel-Drain is the ideal choice for enhanced waterproofing protection of basement walls, plaza decks, earth-sheltered homes, commercial buildings, retaining walls, underground parking, site drainage, etc.



Keene Driwall Composite Drain 10/025-2 (with or without Membrane)

Prefabricated Composite Drain 10/025-2 MEM is a 0.33-inch, "ZIG-ZAG" geometric patterned core, drainage mat designed to eliminate hydrostatic pressure from behind foundation walls, retaining walls, planters and plaza decks, while providing an impermeable membrane surface for the face of the structure. The membrane version provides an impermeable surface for the face of the structure.

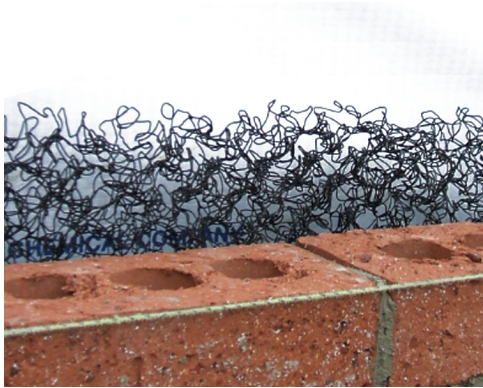

Keene Driwall™ Mortar Deflection (in 1.0-075 or 2.0-160)

Driwall™ Mortar Deflection is a masonry drainage device designed to catch and hold mortar droppings. The 1.0-075 is placed in a strip horizontally in a 1.0-inch (2.5-cm) cavity wall. The 2.0-160 is placed in a strip horizontally in a 2.0-inch (5.0-cm) cavity wall.



Keene Driwall Protection Board

Driwall™ Protection Board is a waterproofing protection and drainage mat that is used after applying the waterproofing membrane to exterior foundation walls to prevent damage when backfilling.

California Stucco (& EZ Wall Base Coat)

Order Code	Product Description	Packaged	Min Order
CS1	Calif.Stucco #1 White 94lb.	per bag	1 bag
CS11	Calif.Stucco #11 Early Mist 94lb.	per bag	1 bag
CS176	Calif.Stucco #176 Brown 94lb.	per bag	1 bag
CS177	Calif.Stucco #177 Red Brick 94lb.	per bag	1 bag
CS180	Calif.Stucco #180 Custom Brick 94lb	per bag	1 bag
CS200	Calif.Stucco #200 Premium Brwn 94lb	per bag	1 bag
CS204	Calif.Stucco #204 Doeskin 94lb.	per bag	1 bag
CS208	Calif.Stucco #208 Summer Sand 94lb.	per bag	1 bag
CS222	Calif.Stucco #222 Pebble 94lb.	per bag	1 bag
CS231	Calif.Stucco #231 Cream 94lb.	per bag	1 bag
CS24	Calif.Stucco #24 Tan 94lb.	per bag	1 bag
CS269	Calif.Stucco #269 Mint Green 94lb.	per bag	1 bag
CS277	Calif.Stucco #277 Coral 94lb.	per bag	1 bag
CS31	Calif.Stucco #31 Ivory 94lb.	per bag	1 bag
CS369	Calif.Stucco #369 Power Blue 94lb.	per bag	1 bag
CS401	Calif.Stucco #401 Pink 94lb.	per bag	1 bag
CS402	Calif.Stucco #402 Shell 94lb.	per bag	1 bag
CS412	Calif.Stucco #412 Brownstone 94lb.	per bag	1 bag
CS414	Calif.Stucco #414 Limestone 94lb.	per bag	1 bag
CS418	Calif.Stucco #418 Charcoal 94lb.	per bag	1 bag
CS45	Calif.Stucco #45 Adobe Buff 94.lb	per bag	1 bag
CS49	Calif.Stucco #49 Straw 94lb.	per bag	1 bag
CS6	Calif.Stucco #6 Dove Gray 94lb.	per bag	1 bag
CS65	Calif.Stucco #65 Sunset 94lb.	per bag	1 bag
CS89	Calif.Stucco #89 Travertine 94lb.	per bag	1 bag
CSELAST	Calif.Stucco Elastocote WHITE 5-Gal	per pail	1 pail
CSELASTC	Calif.Stucco Elastocote CHOOSE COLOR / 5-gal	per pail	2 pail
CSMESH	Calif.Stucco Adhesive MESH Coat / 80 pound bag	per pail	3 pail
CSROLL	Calif.Stucco Roll-Flex WHITE / 5-gal	per pail	4 pail
CSROLL1	Calif.Stucco Roll-Flex WHITE / 1-gal	per pail	5 pail
CSROLLC	Calif.Stucco Roll-Flex CHOOSE COLOR / 5-gal	per pail	6 pail
CSROLL1C	Calif.Stucco Roll-Flex CHOOSE COLOR / 1-gal	per pail	7 pail
CSTEX	Calif.Stucco Texture-Flex WHITE / 5-gal	per pail	8 pail
CSTEX1	Calif.Stucco Texture-Flex WHITE / 1-gal	per pail	9 pail
CSTEXC	Calif.Stucco Texture-Flex CHOOSE COLOR / 5-gal	per pail	10 pail
CSTEX1C	Calif.Stucco Texture-Flex CHOOSE COLOR / 1-gal	per pail	11 pail
EZWALBCC	EZ Wall Base Coat Concentrate 70lb. Bag	per bag	1 bag
EZWALLBC	EZ Wall Base Coat REGULAR 90lb. Bag	per bag	1 bag



California Stucco

California Stucco is world-renowned for its use of White Silica Sand (versus the cheaper Marble Dust in most other stuccos). California Stucco applies thicker and lasts longer than most others too.



Conventional Portland Cement Stucco - The most time proven of all wall coverings. Comes to you containing all the necessary ingredients ready for use with the addition of clean water. It is factory blended in 94 lb. bags, available in 25 colors and will cover 50 square feet.

Texture Flex - Pre-blended elastomeric acrylic polymer coating finish packaged in 60 lb. pails covering approximately 125+ square feet and in a wide variety of colors.

Roll Flex - Top of the line roll on acrylic polymer coating, available in a wide variety of integral colors. Five gallons covers approximately 325 square feet and dries to a approximately 10.3 mils. Excellent for sealing in cracks as well as reviving aged stucco.

Elastocoat - An excellent masonry coating that may be applied by brush, roller, or airless sprayer. It comes in one and five gallon pails in a wide range of colors and will cover approximately 500 square feet per 5 gallons. It may be used over cement stucco, detail work, accent bands, as well as reviving aged stucco.

EZ Wall Base Coat (Regular or Concentrate)

California Stucco E-Z Wall is an pre-blended cement BASE product containing Portland Cement, chopped glass fiber strands, silica sand and proprietary modifiers. It serves as an excellent base for all California Stucco finish products.

Mesh Coat - High percent acrylic – Portland base product which can be used as a foam adhesive and to embed fiber glass mesh to cover foam board and detail work. Packaged in 80 lb. bags covering approximately 140 square feet. Just add water.

Thin Set

Order Code	Product Description	Packaged	Min Order
MTSW	MAPEI Keraset Floor & Wall Thinset WHITE 50# bag	per bag	1 bag
MTSG	MAPEI Keraset Floor & Wall Thinset GREY 50# bag	per bag	1 bag
MTSGMOD	MAPEI Ultraflex2 Multi-Use GREY Thinset 50# bag	per bag	1 bag
MTSWMOD	MAPEI Ultraflex2 Multi-Use WHITE Thinset 50# bag	per bag	1 bag

Skid Discounts: 56 bags/skid OR 42 pails/skid



Keraset Thinset

- Dry-thinset mortar
- For exterior use when mixed with MAPEI Polymer Additive
- Bonds to exterior grade plywood mix with MAPEI Polymer Additive
- For use with ceramic tile over cementitious surfaces or porcelain tile when mixed with polymer additive
- For use in intermittently wet applications when mixed with MAPEI polymer additive
- Mix with MAPEI polymer additive for improved flexibility and adhesion
- Exceeds ANSI A118.1 bond strength requirements when mixed with water; Exceeds ANSI 118.4 and ANSI A118.11 bond strength requirements when mixed with MAPEI Polymer Additive
- May contribute to LEED certification project points



Ultraflex 2 Polymer-Modified Thinset

Ultraflex 2 is a professional-grade, single-component, high-performance, polymer-modified thin-set mortar for interior and exterior installations of ceramic, porcelain and dimensional natural-stone tile. This mortar has a high content of a unique dry polymer, resulting in excellent adhesion to the substrate and tile. Ultraflex 2 meets or exceeds ANSI A118.4E and ANSI A118.11 requirements when mixed with water. Ultraflex 2 can be used for interior and exterior installations of tile in most residential floor and wall applications. In commercial applications, use on interior floor and wall installations and exterior floors.

Repair Mortar

Order Code	Product Description	Packaged	Min Order
SIKA222	SikaRepair 222 Patching Mortar 50lb	per bag	1 bag
PLANX	MAPEI Planitop "X" Fast Repair Mortar 50# Bag	per bag	1 bag
PLANX50	MAPEI Planitop "X" Fast Repair Mortar 50# Pail	per pail	1 pail
PLANXS	MAPEI Planitop "XS" Fast Repair Mortar 50# Pail	per pail	1 pail

Skid Discounts: 56 bags/skid OR 42 pails/skid



SikaRepair 222 Patching Mortar

SikaRepair 222 is a one-component, early strength gaining, cementitious, patching material for horizontal repair of concrete.



MAPEI Planitop "X" Fast Repair Mortar

Renovate, treat, and repair with Planitop X—a one-component, fiber-reinforced, shrinkage-compensated, fast-setting, polymer-modified, high-build cementitious repair mortar with corrosion inhibitor. Light gray to match existing concrete, the product can be applied in thicknesses of featheredge to 4 inches/lift after adding portable mixing water. Use to renovate cast-in-place, precast, tilt-up, or post-tensioned concrete structures; treat blemishes and defects in concrete surfaces; and repair surfaces exposed to high abrasion. Easy to use and fast setting, the product reduces down time and return-to-service issues.



MAPEI Planitop "XS" Fast Repair Mortar

Planitop XS is an extended-working-time variation of Planitop X. Shrinkage compensated, fiber-reinforced, polymer-modified and containing a proprietary corrosion inhibitor, Planitop XS features Planitop X's outstanding workability and versatility, can be applied from featheredge to 4" (10 cm) per lift on vertical surfaces and dries to a light gray color, blending well with most concrete surfaces.

Section 10: Caulks & Chemicals (Damproofing, Waterproofing, Cleaners, Sealants, Coatings, Adhesives, Etc.)

Winter Cement Admixture

Order Code	Product Description	Packaged	Min Order
ANTI	Anti-Hydro Quarts	12/box	1 box
ANTI1	Anti-Hydro Gallons	6/box	1 box
ANTI5	Anti-Hydro 5-Gal.Pail	per pail	1 pail
ANTI55	Anti-Hydro 55-Gal.Drum	per drum	1 drum
ANTI5NC	Anti-Hydro 5-Gal NON-CHLORIDE	per pail	1 pail
HGUARD1	Higroguard Winter Admix Gal.4/CS	4/box	1 box
HGUARD5	Higroguard Winter Admix 5-Gal.Pail	per pail	1 pail
HGUARD55	Higroguard Winter Admix 55gal Drum	per drum	1 drum

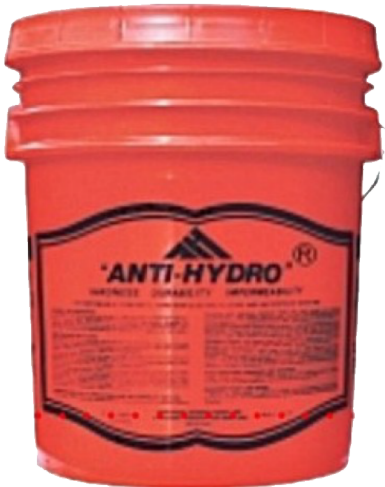

Anti-Hydro® Waterproof Concrete

Anti-Hydro is a combination of organic and inorganic chemicals that reacts with portland cement to produce more complete hydration. Water requirements, bleed water and shrinkage are reduced. The increased hydration provides internal curing and a much denser cement paste. "Anti-Hydro" increases the early and ultimate strength of concrete. These combined reactions produce impermeable concrete that is hard and non-dusting. Anti-Hydro® works with any product containing portland cement (concrete, mortar mix, stucco, & tile grout). Anti-Hydro is the gold standard and only federally approved winter admixture.



HiGRO-GUARD Winter Admixture

****Our most economically priced winter admixture****

A concentrated liquid admixture formulated to accelerate the normal setting time of concrete, to increase early strength development as well as ultimate strength and to provide cold weather protection. HiGRO-GUARD assures uniform curing of concrete – even in low temperatures – resulting in more work days and extended production hours. Concrete work can be satisfactorily performed in temperatures as low as 15 degrees F without the use of auxiliary heat sources.

Same effective temperature range as Anti-Hydro for use as a winter admixture (15-24 degrees: 1:10 / 25-31 deg: 1:12 / 32+ deg: 1:16)

LEXEL Waterproofing Sealant

Order Code	Product Description	Packaged	Min Order
LCC	Lexel Clear Caulk 10.5 fl.oz.Tube	12/box	1 box
LCW	Lexel WHITE Caulk 10.5 fl.oz.Tube	12/box	1 box



LEXEL Waterproofing Sealant

Lexel® is the “duct tape” of all caulks. Super-elastic. Superior adhesion. Paintable. It seals around anything: tubs and shower stalls, sinks and counter tops, window frames and door frames, PVC and metal pipes. Apply to wet or dry surfaces, indoors and outdoors. It’s tough and can handle up to 400% joint movement. It’s scrubbable. It sticks to just about anything. Lexel clear caulk is 19 times clearer than silicone and won’t yellow or cloud up over time. Lexel won’t let you down.

SIKA Construction Sealants

Order Code	Product Description	Packaged	Min Order
SIKAALMOND	Sikaflex 15LM Almond 10.3oz	24/box	1 box
SIKAALSTO	Sikaflex 15LM Aluminum Stone 10.3oz	24/box	1 box
SIKAALUM	Sikaflex 15LM Aluminum Gray 10.3oz	24/box	1 box
SIKABEIGE	Sikaflex 15LM Beige 10.3oz	24/box	1 box
SIKABLACK	Sikaflex 15LM Black 10.3oz	24/box	1 box
SIKABRONZ	Sikaflex 15LM Dark Bronze 10.3oz	24/box	1 box
SIKABRONZM	Sikaflex 15LM Medium Bronze 10.3oz	24/box	1 box
SIKACOL	Sikaflex 15LM Colonial White 10.3oz	24/box	1 box
SIKALIMES	Sikaflex 15LM Limestone 10.3oz	24/box	1 box
SIKARED	Sikaflex 15LM Redwood Tan 10.3oz	24/box	1 box
SIKASTONE	Sikaflex 15LM Stone 10.3oz	24/box	1 box
SIKATAN	Sikaflex 15LM Capitol Tan 10.3oz	24/box	1 box
SIKAWHITE	Sikaflex 15LM White 10.3oz	24/box	1 box



Sikaflex 15LM Construction Sealants

Formulated to be used with moving joints or where high movement capabilities are needed, the Sikaflex-15 LM is a low-modulus, 1-component, polyurethane-based elastomeric sealant. This sealant has a joint movement of +100% / -50%, making it perfect for wall systems, around windows and door frames, high-rise and facade applications.

Sikaflex 15 LM has great adhesion properties, so bonding to most construction materials without a primer is possible. After curing, the non-sag sealant is paintable using water, oil, and rubber based paints to match surrounding materials.

SIKA Construction & Adhesive Sealants

Order Code	Product Description	Packaged	Min Order
SIKA1A	Sikaflex 1A Sealant *WHITE* 10.3oz	24/box	1 box
SIKA1ACOL	Sikaflex 1A Sealant *COLONIAL WHITE* 10.3oz	24/box	1 box
SIKA1AL	Sikaflex 1A Sealant *LIMESTONE* 10.3oz	24/box	1 box
SIKA1ATAN	Sikaflex 1A Sealant *CAPITAL TAN* 10.3oz	24/box	1 box
SIKAGPCLEAR	Sikasil GP Clear 10.3 oz	24/box	1 box



Sikaflex 1a (& GP) Adhesive Sealant

Designed for all types of joints where the maximum depth of sealant will not exceed 1/2 inch, the Sikaflex-1a is a premium-grade polyurethane-based elastomeric sealant. Sika's one part polyurethane can be used for horizontal and vertical applications, the non-sag formula works great on windows, door frames, small joints, and other construction adhesive applications. The pre-mixed, high performance Sikaflex 1a adhesive will bond to most construction materials without a primer. It offers excellent resistance to aging, weathering, jet fuel, and other chemical solvents. This sealant is paintable with water, oil and rubber-based paints and is fast curing for timely installations.

SIKA Construction Adhesive

Order Code	Product Description	Packaged	Min Order
SIKABOND	SikaBond Construction Adhesive 10.3oz	12/box	1 box



SIKA Construction Adhesive

SikaBond Construction Adhesive is a one-component polyurethane that is permanently elastic to allow for natural movement between bonded surfaces. Allows you to bond most building materials including concrete, wood, metal, glass, retaining walls, tile, porcelain, marble, tub surrounds, moulding, mirrors, fiberglass, Styrofoam and more. Its unique formulation allows for permanent water immersion after cure. Can be stored in any temperature without incurring damage to the adhesive if frozen. Can be painted, stained or sanded

SIKA Anchoring Adhesive for Concrete

Order Code	Product Description	Packaged	Min Order
SIKAFIX	Sikadur Anchor Fix-1 10.3oz	12/box	1 box



SIKA Anchoring Adhesive for Concrete

Sika AnchorFix-1 is a specially formulated high-performance, two component anchoring adhesive system for threaded and reinforcing bars in uncracked concrete. Ideal for common anchoring projects such as dowels, bolts, and pins. It can be used with a standard caulk gun. Sets in minutes. Supplied with 2 static mixing nozzles for multiple use. Easy application, no mess

SIKA Grout

Order Code	Product Description	Packaged	Min Order
SIKAGROUT	SikaGrout 212 50lb.Bag	per bag	1 bag



SikaGrout 212 Non-Shrink Grout

SikaGrout 212 is a non-shrink, cementitious grout with a unique 2-stage shrinkage compensating mechanism. It is non-metallic and contains no chloride. With a special blend of shrinkage-reducing and plasticizing/water-reducing agents, SikaGrout 212 compensates for shrinkage in both the plastic and hardened states. A structural grout, SikaGrout 212 provides the advantage of multiple fluidity with a single component. SikaGrout ® 212 meets ASTM C-1107 (Grade C).

SIKA Surface Retardant

Order Code	Product Description	Packaged	Min Order
SIKARUG	Sika Rugasol S Surface Retardant 5-gal	per pail	1 pail



Sika Rugasol S Surface Retardant

Spray Applied, Water Soluble Liquid, Formulated to Retard the Set of Surface Mortar in Concrete to Enable the Aggregate to be Exposed. Architectural quality appearance with original color and texture of the aggregate without sandblasting. Easy, economical removal of the concrete surface without laborious hacking, chipping or blasting required. No danger of acid residue from strong washing compounds. Easy to apply, less supervision of field personnel, no expensive equipment required. Uniform coverage results in uniform aggregate exposure.

SIKA Self-Leveling Joint Sealants

Order Code	Product Description	Packaged	Min Order
SIKA1CSL	Sikaflex-1cSL Self-Lev Seal *LIMESTONE* 29oz	12/box	1 box
SIKA1CSLS	Sikaflex-1cSL Self-Lev Seal *SANDSTONE* 29 oz	12/box	1 box
SIKASL	Sikaflex-1cSL Self-Lev Seal *LIMESTONE* 10.3oz	24/box	1 box



Sikaflex 1cSL Self-Leveling Joint Sealant

Sikaflex-1c SL is a single component, self-leveling, premium-grade polyurethane sealant with an accelerated curing capacity.

Water Repellants

Order Code	Product Description	Packaged	Min Order
SKSILOXP1	Prosoco Siloxane PD 1-gal	4/box	1 box
SKSILOXP5	Prosoco Siloxane PD 5-gal	per pail	1 pail
WSTOP1	Higro Waterstop #3 Gallons 4/CS	4/box	1 box
WSTOP5	Higro Waterstop #3 5-Gal.Pail	per pail	1 pail
WSTOP55	Higro Waterstop #3 55gal Drum	per drum	1 drum
H350	Higro #350 Paver Sealer Quarts 6/CS	6/box	1 box
H3501	Higro #350 Paver Sealer Gal. 4/CS	4/box	1 box
H3505	Higro #350 Paver Sealer 5-Gal Pail	per pail	1 pail
SKNSTWB1	SURE KLEAN Natural Stone Treatment WB 1-gal	4/box	1 box



Sure Klean® Weather Seal Siloxane PD

Sure Klean® Weather Seal Siloxane PD (predilute) is a ready-to-use, water-based silane/siloxane water repellent for concrete and most masonry and stucco surfaces. Siloxane PD will not impair the natural breathing characteristics of treated surfaces. It helps masonry resist cracking, spalling, staining and other damage related to water intrusion. Low odor and alkaline stable, Siloxane PD is ideal for field and in-plant application.



Natural Stone Treatment WB Plus: Extra-strength water-based water repellent

Sure Klean® Weather Seal Natural Stone Treatment WB Plus is a water-based water repellent for limestone, marble and travertine that delivers the same performance as solvent-based products, without the drawbacks of traditional water-based treatments. VOC-compliant, ready-to-use, and low odor, this modified siloxane water repellent was developed to provide long-lasting penetrating protection. Compared to conventional water-based water repellents, Natural Stone Treatment WB Plus has greater water-repellency, longer service-life and is less likely to stain. Use of this product will not alter the substrate's natural texture but may cause some darkening. Always test to ensure desired results before overall application.

“Admixture” Cement Bonding Agents

Order Code	Product Description	Packaged	Min Order
ACRYL	Acryl 60 (MasterEmaco A 660) Quarts	8/box	1 box
ACRYL1	Acryl 60 (MasterEmaco A 660) Gallons	4/box	1 box
ACRYL5	Acryl 60 (MasterEmaco A 660) 5-Gallon Pail	per pail	1 pail
SIKAR1	SikaLatex R Bondng Agent/Admix 1-gallon	4/box	1 box
SIKAR5	SikaLatex R Bondng Agent/Admix 5-gallon	per pail	1 pail



MasterEmaco A 660 (formerly Acryl 60)

MasterEmaco A 660 (formerly Acryl 60) is an acrylic-polymer emulsion mixed with Portland cement mortars, plasters, stucco, and concrete mixes to enhance their physical properties, adhesion to substrates, and durability.



Sika® Latex R

An acrylic based, polymer emulsion. It is non-reemulsifiable and multi-purpose in its use as an admixture to produce latex improved bonding agents, concrete and mortar.

Use as a liquid admixture in cement mortars and concrete to enhance adhesion and overall performance, for sand and cement bonding grouts, with stucco and terrazzo, for patching and flash coats, and as a polymer admixture added to SikaRepair® mortars to further improve their performance.

“Surface Applied” Cement Bonding Agents

Order Code	Product Description	Packaged	Min Order
WELD	Weld-Crete Qts 12/Cs	12/box	1 box
WELD1	Weld-Crete Gallons 4/Cs	4/box	1 box
WELD5	Weld-Crete 5-Gallon Pail	per pail	1 pail
TBOND1	Thorobond 1-Gallon (MasterProtect P110)	4/box	1 box
TBOND5	Thorobond 5-Gallon Pail (MasterProtect P110)	per pail	1 pail
PLASTER	Plaster-Weld Qts 12/Cs	12/box	1 box
PLASTER1	Plaster-Weld Gallons 4/Cs	4/box	1 box
PLASTER5	Plaster-Weld 5-Gallon Pail	per pail	1 pail



Weld-Crete Concrete Bonding Agent

Weld-Crete® bonds new concrete, stucco, tile setting beds and terrazzo to any structurally sound surface, interior or exterior. Use Weld-Crete's® open time to your advantage in bonding to concrete shear walls when you need a time lapse between application of bonding agent, placement of reinforcement steel, placement of formwork and placement of concrete. The original chemical concrete bonding agent incorporates polyvinyl acetate homopolymer in a patented formulation.



Plaster-Weld

Plaster-Weld® bonds new plaster to any clean, structurally sound, interior surface. The original chemical plaster bonding agent is a patented formulation incorporating polyvinyl acetate homopolymer. DESIGNED FOR INTERIOR USE ONLY, the high performance bonding of one-coat finish plaster and/or two and three coat work to concrete ceilings, walls, columns, beams, and other structurally sound surfaces. Plaster-Weld® prepares the surface to allow you to plaster directly to concrete over electric radiant heat cable, and to bond cement mortar beds to smooth concrete for installation of rigid foam insulation.



MasterProtect P 110 (formerly Thorobond)

A water-based polyvinyl acetate bonding agent that enhances adhesion of plaster or concrete mortars to concrete, masonry, drywall, plaster, browncoats and stucco. Recommended use is for bonding plaster or concrete mortar to cementitious or gypsum-based materials.

Waterproof Coatings

Order Code	Product Description	Packaged	Min Order
TSEALG60	Thorseal Gray 60# Pail (MasterSeal 581)	per pail	1 pail
TSEALW60	Thorseal White 60# Pail (MasterSeal 581)	per pail	1 pail



MasterSeal 581 (formerly Thoroseal)

MasterSeal 581 is a portland cement-based coating for concrete and masonry that resists both positive and negative hydrostatic pressure. Polymer-modified with MasterEmaco A 660, MasterSeal 581 creates a low maintenance and highly durable waterproof barrier.

Quickset Hydraulic Cement Additive

Order Code	Product Description	Packaged	Min Order
WATP10	Waterplug (MasterSeal 590) 10# 1-Gallon	4/box	1 box
WATP50	Waterplug (MasterSeal 590) 50# 5-Gallon Pail	per pail	1 pail
TRITE60	Thororite 60# Pail (MasterEmaco N 424 or EMACO GP)	per pail	1 pail
SIKAPLUG50	SikaPlug Fast-Set Water Stop 50lb.	per pail	1 pail



MasterSeal 590 (formerly Waterplug)

MasterSeal 590 is a one-component, quick-setting, portland-cement-based hydraulic repair mortar that instantly stops running water through holes or cracks in concrete or masonry. It expands as it sets to lock into place even under constant water pressure.



Master Emaco N 424 (formerly Thororite or Emaco GP)

MasterEmaco N 424 is a general purpose, fast-setting, non-sag cement-based repair mortar for small repairs on vertical, horizontal, and overhead surfaces. Non-sag consistency able to be placed in 1" (25 mm) thick lifts. Can be mixed with MasterEmaco A 660 to increase high-performance properties



Sika SikaSet Plug Waterstop

SikaSet Plug Waterstop is a versatile, fast-setting, portland-cement water-stop. When mixed with water it becomes a mortar/grout to stop pressure leakage and seepage. Use in sewers, wastewater treatment plants, basements, sumps, pools, tunnels, and other applications. Also good for use in grouting railings of wood, concrete, and metal.

Decorative Cement Treatments

Order Code	Product Description	Packaged	Min Order
TCOAT5	Thorocoat 5-Gallon Pail (MasterProtect HB400)	per pail	\$750/min
TLASTIC5	Thorolastic 5-Gallon Pail (MasterProtect EL750)	per pail	\$750/min



MasterProtect HB 400 (formerly Thorocoat)

A water-based, high-build, 100% acrylic, waterproof coating for above-grade concrete, masonry, stucco, and EIFS. Recommended uses: Exterior / Vertical and overhead surfaces / Above grade / Protecting and waterproofing



MasterProtect EL 750 (formerly Thorolastic)

A water-based, high-build, elastomeric, 100% acrylic waterproof coating for above-grade concrete, masonry, stucco and EIFS. Recommended uses: Exterior / Vertical surfaces / Above grade / Protecting and waterproofing

Foundation Coating

Order Code	Product Description	Packaged	Min Order
FC5	Del-Val Non-Fib Foundation Coating 5-gal	per pail	1 pail
FC55	Del-Val Non-Fib Foundation Coating 55-gal	per drum	1 drum
HLM5000	Sonoshield HLM5000 (MasterSeal HLM5000) 5-gal 2 Grades - "Trowel" or "Roller"	per pail	1 pail
KAR112	KARNAK #112 Foundation Coating 5-gal	per pail	1 pail
KAR19	KARNAK #19 Ultra Rubberized Flashing Cement 5-gal	per pail	1 pail
KAR86	KARNAK #86AF Trowel Mastic 5-gal	per pail	1 pail
KAR88	KARNAK #88 Rubberized Waterproofing 5-gal	per pail	1 pail



DEL VAL Non-Fibred Roof/Foundation Coating

Del-Val Non Fibred Roof / Foundation Coating is a non-fibred asphalt coating that is used to prevent moisture penetrating through foundation walls and protecting a variety of roof surfaces. After the product is applied it forms a smooth flexible shell that helps resist the entrance of moisture through foundation walls. On the roof Del-Val Non Fibred Roof Coating forms a weather resistant film that has excellent adhesion to most roof surfaces.



Karnak #112 Foundation & Roof Coating

Karnak #112 Foundation & Roof Coating is a non-fibred asphalt coating for preventing moisture penetration through foundation walls and protecting a variety of roof surfaces. The finished coating forms a smooth, tough, flexible film that serves to help retard the entrance of moisture into or through the foundation wall. On the roof it helps to extend the life of a variety of roofing systems. If a hydrostatic pressure condition is present against the foundation wall, Karnak recommends using a Karnak waterproofing product such as Karnak 88R Rubberized Waterproofing (Aqua-Block), or Karnak 229AR-Elastomeric.

Karnak #112 Foundation & Roof Coating can be applied on exterior below grade and interior above grade block and masonry walls where no hydrostatic pressure is present. Use to coat all types of smooth surface asphalt roofs. Can also be used to protect wood and metal above or below grade.



Sonoshield HLM5000 (MasterSeal HLM5000)

HLM 5000 Roller Grade Liquid, Cold-applied Elastomeric Waterproofing is a one-component, moisture-curing, bitumen-modified polyurethane elastomeric waterproofing membrane for exterior below-grade or between-slab applications.



Karnak #19 Ultra Flashing Cement

Karnak #19 Ultra Flashing Cement is the next generation flashing cement. Scientifically compounded with a selection of rubber reinforced asphalt, mineral fibers, and refined solvents. Karnak #19 Ultra Flashing Cement is a general purpose flashing cement for repairing leaks in shingles, concrete, metal or asphalt roofs, flashings on walls, chimneys, flues, skylight flashings, downspouts and cornices. 19 Ultra is excellent for sealing cracks in concrete and brick, as a joint filler for precast roof slabs and for general purpose use in maintenance of exposed buildings and structures. Karnak #19 Ultra is available in 3 consistencies: Summer, Semi and Winter.



Karnak #88R Rubberized Waterproofing

Karnak #88R Rubberized Waterproofing is a solvent based asphalt compound, spray grade, manufactured with selected asphalts, stabilizers, polymer modifiers and mineral spirits. Karnak #88R Rubberized Waterproofing is designed to waterproof masonry and concrete exterior below grade surfaces and interior surfaces above grade. Karnak #88R also functions as a vapor barrier and air barrier. This product is suitable as a general protective coating for wood, steel and for all backup materials for masonry such as stone, brick and concrete. This protective coating also helps to control moisture and inhibit air leakage in buildings as specified in a number of building codes.



Karnak #86AF Fibered Trowel Mastic

Karnak #86AF Fibered Trowel Mastic is manufactured from a blend of selected asphalts, fibers, stabilizers, fillers and solvents. Karnak #86AF Fibered Trowel Mastic is especially recommended for application as a protective coating for exterior masonry walls below grade and exterior face of interior walls (cavity wall construction), and as a damp proofing product for retaining walls, bridge abutments and steel panels. It is also used for the coating of interior faces of exterior masonry walls above grade, and for all back-up material for masonry, such as stone, brick or concrete. Karnak #86AF Fibered Trowel Mastic can be used for waterproofing when used in conjunction with a multi-membrane application.

Liquid Surface Curing, Hardening, & Sealing

Order Code	Product Description	Packaged	Min Order
ACUR1	Acuricon (Anti-Hydro) Gallons	6/box	1 box
ACUR5	Acuricon (Anti-Hydro) 5-Gal.Pail	per pail	1 pail
ACUR55	Acuricon (Anti-Hydro) 55 Gallon Drum	per drum	1 drum
ARMO1	Armortop (Anti-Hydro) Gallons	6/box	1 box
ARMO5	Armortop (Anti-Hydro) 5-Gal.Pail	per pail	1 pail
ARMO55	Armortop (Anti-Hydro) 55-Gal.Drum	per drum	1 drum
3WAYS5	3-Way Sealer (Anti-Hydro) 5-Gal.Pail	per pail	1 pail
HCS1	Higro Cure & Seal WB Gallons 4/CS	4/box	1 box
HCS5	Higro Cure & Seal WB 5-Gal.Pail	per pail	1 pail



Acuricon by Anti-Hydro

ACURICON is a one step, water borne chemical type, concrete curing compound that has been extensively used and specified over many decades for curing, hardening and dustproofing concrete surfaces. It is also available with fugitive dye and complies with AIM VOC requirements. ACURICON treated surfaces are suitable for potable water use and will not interfere with subsequent finishing.

Armortop by Anti-Hydro

Armortop has been extensively used and recommended over many decades for chemical surfaces. Armortop also renders the treated surfaces resistant to abrasion and many chemicals. It also extends the life of a concrete surface many fold and lowers maintenance costs.

3-Way Sealer by Anti-Hydro

3 WAY SEALER WB is a water borne, film forming, high solids resin emulsion that has been extensively used and specified over many decades as curing, sealing and protective coatings on concrete surfaces, new or existing, interior or exterior. A-H® 3 WAY SEALER WB forms a continuous uniform film that adheres to concrete producing sealed, hardened and protected concrete surfaces that are resistant to chloride salts, gasoline and oil, and water penetration. Typical applications include parking garage slabs, warehouse floors, and any concrete where maximum protection is required. It complies with AIM VOC requirements.

HiGRO Cure & Seal – Concrete Coating for Fresh or Existing Concrete

A formulation based aqueous dispersion of styrene/acrylate polymer which will effectively cure, harden, rustproof and seal freshly poured concrete in one simply solution. On older concrete, it is an effective seal coat that is resistant to acids, alkalis, salts, oils, and other potentially destructive chemicals. It will also promote excellent adhesion of tile and carpet adhesives. It may be used on exterior concrete surfaces to prevent spalling from de-icing salts and guard against freeze-thaw deterioration. Exceeds the moisture retention and dry time requirements of ASTM C309.

Form Release & Form Coating

Order Code	Product Description	Packaged	Min Order
FORM5	AH Form Free WB 5 Gal.Pail	per pail	1 pail
FORM55	AH Form Free WB 55-Gallon Drum	per drum	1 drum
DUOG5	Duoguard H.E. Form Release 5 Gal Pail	per pail	1 pail



Duoguard N.E. Form Release by W.R. Meadows

Duoguard N.E. is a multi-reactive form release agent specifically formulated for the Northeastern United States. It is composed of an organic chemical that reacts with the alkali content of the concrete to form a release film that effectively prevents the bonding of concrete to the form.

Form Free WB by Anti-Hydro – Chemical Release Agent to Prevent Bond of Concrete to Forming Materials

Form Free WB is a combination of highly refined fatty acids in a hydrocarbon solvent which reacts chemically with the alkalis in concrete leaving a fine powder residue between the form work and the concrete. After stripping the forms, the residue is easily brushed or washed away. Form Free WB is free of kerosene, oil, waxes, and resins, and will not stain the concrete. It is compatible with all types of forms: Wood, Fiber, Glass, Paper, Masonite, Aluminum, Concrete

Roof Cement and Coating

Order Code	Product Description	Packaged	Min Order
RCE5	Roof Cement 5-Gallon Pail	per pail	1 pail



Del-Val 211 Flashing Cement is a high-quality cement that is formulated to a heavy smooth trowel consistency. This product is used as a cold applied flashing cement in many types of asphalt roof membranes. Del-Val 211 Flashing Cement is ideal for flashing details and a variety of waterproofing repairs such as roof penetrations and moving joints.

Concrete/Paver Cleaners and Restorers

Order Code	Product Description	Packaged	Min Order
SK1011	SURE-KLEAN 101 Lime Solvent 1-gal	4/box	1 box
SK1015	SURE-KLEAN 101 Lime Solvent 5-gal	per pail	1 pail
SK6001	SURE-KLEAN 600 Detergent 1-gal	4/box	1 box
SK6005	SURE-KLEAN 600 Detergent 5-gal	per pail	1 pail
SKVANA1	SURE-KLEAN Vana Trol 1-gal	4/box	1 box
SKVANA5	SURE-KLEAN Vana Trol 5-gal	per pail	1 pail
SKRESTC1	SURE-KLEAN Restoration Cleaner 1-gal	4/box	1 box
SKRESTC5	SURE-KLEAN Restoration Cleaner 5-gal	per pail	1 pail
SKSAFETY1	SURE-KLEAN Safety Klean 1-gal	4/box	1 box
SK8001	SURE KLEAN 800 Stain Remover 1-gal	4/box	1 box
SKASTR1	SURE-KLEAN Asphalt & Tar Remover 1-gal	4/box	1 box
SKBIOW1	SURE-KLEAN ReVivie (BioWash) 1-gal	4/box	1 box
SKCMC1	SURE-KLEAN Custom Masonry Cleaner 1-gal	4/box	1 box
SKCMC5	SURE-KLEAN Custom Masonry Cleaner 5-gal	per pail	1 pail
SKFAST1	SURE-KLEAN Fast Acting Stripper 1-gal	4/box	1 box
SKHDCONC1	SURE-KLEAN HD Concrete Cleaner 1-gal	4/box	1 box
SKHDCONC5	SURE-KLEAN HD Concrete Cleaner 5-gal	per pail	1 pail
SKHDPS1	SURE-KLEAN HD Paint Stripper 1-gal	4/box	1 box
SKHDPS5	SURE-KLEAN HD Paint Stripper 5-gal	per pail	1 pail
SKHRESTC	SURE-KLEAN HD Restoration Cleaner NE 5-gal	per pail	1 pail
SKLDONC1	SURE-KLEAN Lt Duty Concrete Cleaner 1-gal	4/box	1 box
SKLSREST1	SURE-KLEAN Limestone Restorer 1-gal	4/box	1 box
SKLSREST5	SURE-KLEAN Limestone Restorer 5-gal	per pail	1 pail
SKCLEAN1	PAVER KARE Cleaner/Brightener 1-gal	4/box	1 box
SKMAINTCLN1	PAVER KARE Maintenance Cleaner 1-gal	4/box	1 box
SKPAVENH1	PAVER KARE Paver Enhancer 1-gal	4/box	1 box



Sure Klean® 101 Lime Solvent: Concentrated Cleaner for New Masonry

Sure Klean® 101 Lime Solvent is a concentrated acidic cleaner for dark-colored brick and tile surfaces which are not subject to metallic oxidation. Safely removes excess mortar and construction dirt with simple cold water rinse. Removes efflorescence from new brick and new stone construction. Safer than muriatic acid on colored mortar and dark-colored new masonry surfaces



Sure Klean® 600: New Masonry Cleaner

The No. 1-selling proprietary cleaner for new masonry. Sure Klean® 600 is a general purpose, concentrated acidic cleaner for brick, tile and concrete surfaces. Dissolves mortar smears and construction dirt quickly, leaving the masonry clean and uniform with no acid burning or streaking. Safer than muriatic acid for new masonry surfaces



Sure Klean® Vana Trol®: Sensitive Brick & Stone Cleaner

Sure Klean® Vana Trol® is a concentrated acidic cleaner for new masonry surfaces that are subject to vanadium, manganese and other metallic stains. Vana Trol® is designed to simplify rinsing and reduces potential for efflorescence.



Sure Klean® Heavy Duty Restoration Cleaner NE: Ultra Powerful Carbon and Pollution Remover

Sure Klean® Heavy Duty Restoration Cleaner NE is a concentrated acidic cleaner specifically made to attack and wipe out the heaviest atmospheric staining the Northeast U.S. urban and industrial environment can produce on brick, terra cotta, granite, sandstone and more. Used carefully, this ultra-powerful formulation breaks loose and dissolves the decades of dirt, paint oxidation, carbon buildup and other atmospheric pollutants that can prove too difficult for other cleaners. A simple cold-water rinse then removes these unsightly stubborn stains, revealing the masonry's original beauty.



Enviro Klean® Safety Klean: Low Corrosion Cleaner For New Masonry

Enviro Klean® Safety Klean is an effective, safe alternative to acidic compounds for cleaning brick, tile and concrete surfaces. Safety Klean rids new masonry construction of excess mortar, dirt and other common job site soiling. It's ideal for projects where traditional acidic cleaners are not allowed. Non-fuming Safety Klean contains no hydrochloric or other traditional inorganic acids and is safe for use on and around most metal surfaces, indoors or out. It is up to 70 percent more effective than citric and glycolic acids, and 50 percent more effective than phosphoric acid.



Sure Klean® 800 Stain Remover

Sure Klean® 800 Stain Remover is a specialty masonry cleaning product that effectively removes green vanadium stains commonly found in buff or white brick. 800 Stain Remover also removes straw stains, acid burns and other metallic discolorations from most masonry surfaces.



Sure Klean® Asphalt & Tar Remover: Heavy duty cleaner for masonry and concrete

Sure Klean® Asphalt & Tar Remover is a highly efficient multipurpose solvent cleaner for masonry and concrete. It is easy to apply and water rinsable. Ideal for cleaning and surface preparation, Asphalt & Tar Remover will not damage most masonry or concrete. Removes many sealers and protective treatments such as old curing compounds, acrylic, stearate, and chlorinated rubber sealers



Enviro Klean® ReVive (previously BioWash): Biological Soiling Remover For Monuments & Gravestones

Enviro Klean® ReVive (previously BioWash) removes mold and mildew staining and atmospheric soiling that disfigures and degrades many types of construction materials. ReVive is a highly efficient alternative to aggressive cleaners traditionally used on interior and exterior masonry, stone and tile surfaces. ReVive can also be applied safely to non masonry substrates such as wood, painted surfaces, metal, plastic and glass.



Sure Klean® Custom Masonry Cleaner: Concentrated concrete cleaner and brightener

Sure Klean® Custom Masonry Cleaner removes concrete splashes, excess mortar, mud, retarders, heavy efflorescence, embedded stains, rust and surface soiling from textured custom masonry surfaces. This concentrated, general-purpose acidic cleaner improves the color and uniformity of most custom masonry and colored concrete. When used in strong solutions, Custom Masonry Cleaner can be used for additional aggregate exposure (“weathering”).



Sure Klean® Fast Acting Stripper: Multi-layer paint remover

Sure Klean® Fast Acting Stripper is a thixotropic stripping compound designed for removing coatings and epoxies from masonry, wood and metal surfaces. It also removes oil, grease and waxes from concrete decks, tile and terrazzo floors. Effectively removes yellowed sealers and wax build-up as well as a variety of paint coatings and graffiti. Specially formulated for removing the toughest coatings – effectively removes epoxy, polyurethanes and other high strength coatings. Excellent for stripping oil, grease and built-up coatings from concrete decks.



Sure Klean® Heavy Duty Concrete Cleaner: Concentrated power cleaner for concrete

Sure Klean® Heavy Duty Concrete Cleaner is formulated for removal of concrete splashes, excess mortar, retarders, heavy efflorescence, embedded stains, rust and surface soiling from textured concrete surfaces.

This concentrated, general-purpose acidic cleaner improves the color and uniformity of most standard concrete, colored concrete, precast panel and concrete block surfaces. When used in strong solutions, Heavy Duty Concrete Cleaner will etch concrete, It can be used for additional aggregate exposure ideal for “weathering” architectural concrete.



Sure Klean® Heavy Duty Paint Stripper: Multi-layer paint remover

Sure Klean® Heavy Duty Paint Stripper, an alkaline formula with organic solvents, removes multiple layers of paint and graffiti from masonry surfaces. This “slow-working” extended-contact remover, remains active for 24 hours. One application of Heavy Duty Paint Stripper dissolves heavy accumulations of paint, restoring old masonry to its original appearance. Heavy Duty Paint Stripper contains no methanol, methylene chloride, or chlorinated solvents, and is water rinsable and nonflammable.



Sure Klean® Heavy Duty Restoration Cleaner NE: Ultra Powerful Carbon and Pollution Remover

Sure Klean® Heavy Duty Restoration Cleaner NE is a concentrated acidic cleaner specifically made to attack and wipe out the heaviest atmospheric staining the Northeast U.S. urban and industrial environment can produce on brick, terra cotta, granite, sandstone and more.

Used carefully, this ultra-powerful formulation breaks loose and dissolves the decades of dirt, paint oxidation, carbon buildup and other atmospheric pollutants that can prove too difficult for other cleaners. A simple cold-water rinse then removes these unsightly stubborn stains, revealing the masonry’s original beauty.



Sure Klean® Light Duty Concrete Cleaner: General Purpose And New Construction Stain Remover

Sure Klean® Light Duty Concrete Cleaner is specially formulated to remove common construction and atmospheric staining from a variety of substrates, including smooth architectural and engineered concrete, custom masonry, concrete brick, manufactured stone and decorative pavers. This general-purpose, non etching acidic cleaner removes rust, mud, atmospheric dirt, mortar smears and other stains without altering the surface texture. Light Duty Concrete Cleaner adds depth to colors, brightens white matrices and exposed aggregate.



Sure Klean® Limestone Restorer: Unpolished Limestone & Cast Stone Cleaner

Sure Klean® Limestone Restorer is a concentrated acidic cleaner for unpolished limestone, concrete and cast stone surfaces. Safely removes atmospheric dirt, mildew and many other surface stains without risk of bleaching or discoloration. Ideal for lightly to moderately soiled surfaces. Limestone Restorer is safer and easier to use than conventional acidic or abrasive cleaning systems. Contains no hydrofluoric acid. Use in combination with pressure water rinsing.



Paver Kare® Paver Enhancer: Water Repellent & Color Intensifier For Concrete

Paver Kare® Paver Enhancer is a solvent-based blend of high-quality siloxanes modified to provide excellent water repellency and color enhancement to interlocking concrete, fired clay, porous tile and many types of natural stone surfaces. Paver Enhancer penetrates and reacts with the surface to form a chemical bond, providing long-term durability, alkali resistance and superior breathability.